



WAC

2025



WAC LIGHTING®

Fueled by a passion for creation, WAC proudly celebrates 40 years of excellence, operating at the forefront of innovation, advanced technology-driven production, and an integrated, quality-focused approach. As a leader in lighting innovation, we are committed to delivering cutting-edge products that combine forward-thinking design with state-of-the-art technology.

Our process is driven by extensive research, utilizing the most advanced LEDs, pioneering materials engineering, and precision optical design—unlocking endless possibilities for modern lighting solutions. Backed by a team of creative problem-solvers, we tackle your most

complex lighting needs with the latest advancements in technology.

Every design undergoes rigorous testing in our dedicated internationally recognized NVLAP, UL, ETL, and cETL accredited testing labs to ensure safety, durability, and long-term performance. Above all, we are a company that cares deeply about our people, our products, our reputation, and our clients. Our mission is rooted in merit, with a vision to become the most respected lighting company and a shining example of American ingenuity. Thank you for inspiring us to imagine, innovate, and illuminate.

TABLE OF CONTENTS

RECESSED

Page 2

- OCULARC 2.0**® Upgraded to 5CCT Selectable
- OCULARC 3.0**® Upgraded to 5CCT Selectable
- AETHER ATOMIC** Now Available in Dim-To-Warm
- AETHER 2"** Low Glare Housing Remodel

TRACK + MONOPOINT

Page 14

- OCULARC**® **7011** Upgraded to 5CCT Selectable
- OCULARC 7030** Upgraded to 5CCT Selectable
- OCULARC 7012** NEW
- OCULARC 7013** NEW
- OCULARC 3020** Upgraded to 5CCT Selectable
- OCULARC MO-3020** Upgraded to 5CCT Selectable

INVISILED

Page 22

- INVISILED Lite+** 150 lm/ft + Chip-on-Board technology
- INVISILED Pro+** 200 lm/ft + Chip-on-Board technology
- INVISILED Pro2+** 300 lm/ft + Chip-on-Board technology
- INVISILED Channels** New recessed and angled profiles

WAC LIMITED

Page 34

- GEMINI** NEW Kit
- UNDER CABINET** NEW
- LOTOS R** Retrofit NEW
- LOTOS R** Best Seller
- KENRIC** NEW
- ION** NEW
- TWIST-N-LITE** NEW
- ROUND** NEW
- DEW** NEW
- I CAN'T BELIEVE IT'S NOT RECESSED** Upgraded to 5CCT Selectable
- DISC** Upgraded to 5CCT Selectable
- PORTABLE TABLE LAMPS** NEW
- CAP** NEW
- LANTERN** NEW
- MIDTOWN** NEW Size
- VEGA** Upgraded to 5CCT Selectable
- CHARGE** NEW
- SOLO** NEW
- BULLET** Upgraded to 5CCT Selectable
- CYN** NEW



RECESSED

Architectural recessed lighting solutions provide cutting-edge LED illumination at different light levels for various applications, from wall wash and downlighting to accent lighting. Our vast array of lighting fixtures provides symmetrical, asymmetrical, direct, or indirect illumination with various specifiable options such as beam angles, light distribution, and glare control. Advanced engineering and rigorous testing apply to every fixture in our LED portfolio.

OCULARC

Performance Simplified. Specialized in integrating technological advancement with forward-thinking design, the award-winning Ocularc LED luminaires set the standard for residential, commercial, and hospitality applications. High-performance illumination delivered from a single point source LED module with a clean, efficient, versatile design. 90 CRI minimum high color rendering LED and versatile dimming protocols set the standard. A diverse range of optics includes Dim-to-Warm versatility—pure white 3000K light for a bright task environment or an inviting hotel lobby, and a warm 1800K to create the perfect mood for cozy living rooms or romantic restaurant seating. The CCTs include warm white 2700K, 3000K, 3500K, neutral white 4000K and cool 5000K, to fulfill all of your white light temperature needs.

AETHER

Aether + Aether Atomic Minuscule & mighty, peerless & powerful, the new potent Aether Atomic launches into the light. An engineering recessed marvel for next-generation futurists. Sublime and serviceable, it's an icon for the ages. Atomic breaks the mold. Dim-to-Warm technology lets you dim to a more intimate, calming glow at 1800K candlelight ambiance, which is great for primary baths, dining rooms, home theaters, and other spaces. These fixtures effectively reduce glare and provide a comfortable lighting environment. Aether also offers additional groundbreaking models for shallow plenum spaces.

OCULARC 2.0 LED RECESSED

POWERFUL MINIMALISM



- Sold as new construction. May be configured in the field for remodel use
- Cutout: 3 1/8"
- Single LED module for high-performance illumination without hot spots
- Ceiling thickness: 1/2"-1 1/2"
- Dimming: 100%-5% TRIAC, ELV, 0-10V

Aperture: 2"
Power: 11W/12W
Input: 120-277V
Rated Life: 50,000 hours

CCT selectable output on physical power supply switch



	Model	Beam	Max Lumens	Max CBCP	Color Temp	CRI	Finish
	R2BRD Round Open Reflector Wet Location	S 18°	955 (12W)	5935	CS	90	BK Black BN Brushed Nickel HZWT Haze/ White WT White
		N 24°					
		F 55°					
		2700K					
		3000K					
	R2BRA Round 0-35° Adjustable	S 18°	870 (11W)	5390	CS	90	BK Black BN Brushed Nickel WT White
		N 24°					
		F 55°					
		2700K					
		3000K					
	R2BSD Square Open Reflector Wet Location	S 18°	940 (12W)	6005	CS	90	BK Black BN Brushed Nickel HZWT Haze/ White WT White
		N 24°					
		F 55°					
		2700K					
		3000K					
	R2BSA Square 0-35° Adjustable	S 18°	880 (11W)	5515	CS	90	BK Black BN Brushed Nickel WT White
		N 24°					
		F 55°					
		2700K					
		3000K					

Example: **R2BRD-SCS-WT**

INTEGRAL HOUSING AND TRIM: BOTH NEW CONSTRUCTION & REMODEL

NEW CONSTRUCTION CONFIGURATION

IC Rated Airtight

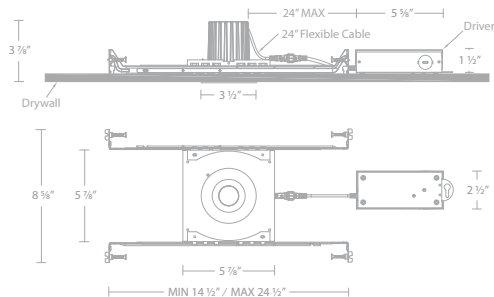

REMODEL CONFIGURATION

IC Rated Airtight

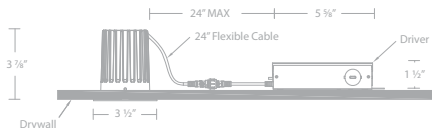

All-in-one unit, ready to install right out of the box



OCULARC 3.0 & OCULARC 3.0 DIM-TO-WARM

THE WORKHORSE



- Sold as new construction. May be configured in the field for remodel use
- Cutout: 4 1/4"
- Single LED module for high-performance illumination without hot spots
- Ceiling thickness: 1/2"–1 1/2"
- Dimming: 100%-5% TRIAC, ELV, 0-10V

Aperture: 3"
Power: 13W
Input: 120-277V
Rated Life: 50,000 hours

	Model	Beam	Max Lumens	Max CBCP	Color Temp	CRI	Finish
	R3BRD Round Open Reflector Wet Location	S Spot N Narrow F Flood	1045	8820	CS 2700K 3000K 3500K 4000K 5000K	90	BK Black BN Brushed Nickel HZWT Haze/White WT White
	R3BRDN		765	3070	WD 3000K-1800K	95	BK Black WT White
	R3BRDP Polycarbonate Trim Face* Open Reflector	S Spot N Narrow F Flood	1040	8545	CS 2700K 3000K 3500K 4000K 5000K	90	WT White
	R3BRA Round 0-35° Adjustable	S Spot N Narrow F Flood	1060	8925	CS 2700K 3000K 3500K 4000K 5000K	90	BK Black BN Brushed Nickel WT White
	R3BRAN		745	2820	WD 3000K-1800K	95	BK Black WT White
	R3BSD Square Open Reflector Wet Location	S Spot N Narrow F Flood	1040	8510	CS 2700K 3000K 3500K 4000K 5000K	90	BK Black BN Brushed Nickel HZWT Haze/White WT White
	R3BSDN		735	2850	WD 3000K-1800K	95	BK Black WT White
	R3BSA Square 0-35° Adjustable	S Spot N Narrow F Flood	1070	8905	CS 2700K 3000K 3500K 4000K 5000K	90	BK Black BN Brushed Nickel WT White
	R3BSAN		745	2820	WD 3000K-1800K	95	BK Black WT White

Example: **R3BRD-SCS-WT**

*Conforms to local code Dead Front requirements

INTEGRAL HOUSING AND TRIM: BOTH NEW CONSTRUCTION & REMODEL

NEW CONSTRUCTION CONFIGURATION

IC Rated Airtight

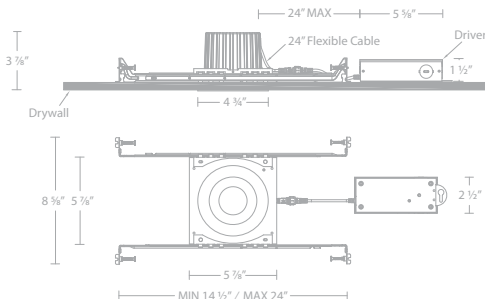

REMODEL CONFIGURATION

IC Rated Airtight

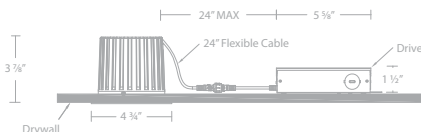

All-in-one unit, ready to install right out of the box



AETHER ATOMIC

DIMINUTIVE TRIMLESS LED RECESSED

Power: 11W
 Input: 600mA 18V DC
 Dimming: 100% - 1% ELV, TRIAC (120V only), 0-10V, DMX
 Rated Life: 50,000 hours
 Ceiling Thickness: 1/2" - 2"
 Ceiling Cutout: 6/12" (Remodel), 6" (New Construction)

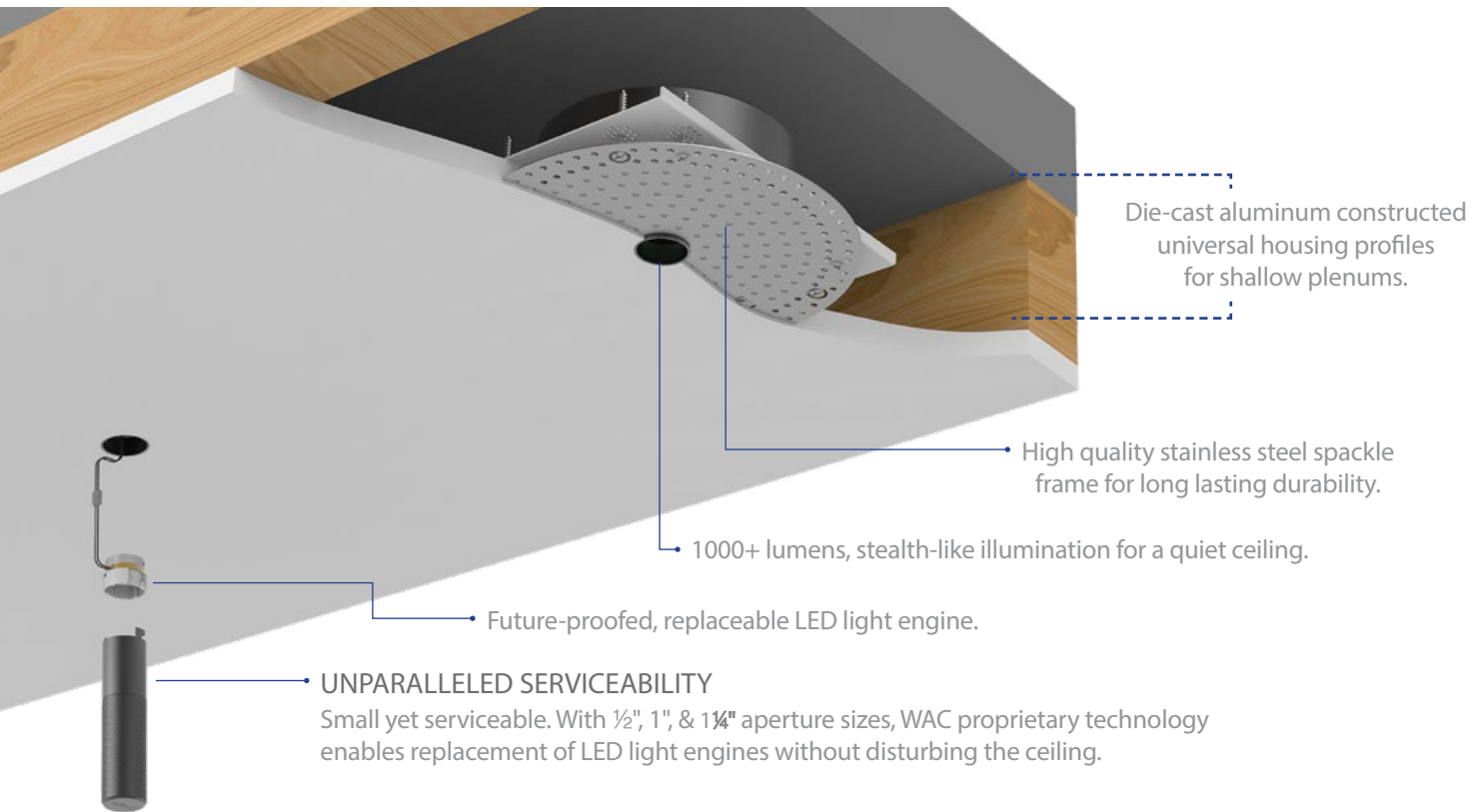

WHY CHOOSE 1" DOWNLIGHT?

Low glare, robust lumen output from a 1" aperture. Three high efficiency reflectors are included and field changeable.

WHY CHOOSE 1/2" PINHOLE?

Dramatic, lower lumen illumination from a more discreet source. Two high efficiency reflectors are included and field changeable.

WHY CHOOSE ADJUSTABLE?

Aimable accenting and sloped ceiling applications. Three high efficiency reflectors are included and field changeable.

WHY CHOOSE WALL WASH?



Discreetly illuminate a wall with a smooth wash of light across a wall or façade.

FIELD CHANGEABLE OPTICS →



FEATURE RICH →



Remote Power Supply (Required)	Model	Input	Output	Dimmable	Dimensions
	PS-0600A-UR1	120V - 277V	600mA 18V DC 1 Channel UL Class 2	100%-1% ELV, TRIAC, 0-10V	8 3/4" x 2" x 1 3/8"
	PS-0600A-UR6	120V - 277V	600mA 18V DC 6 Channel UL Class 2	100%-1% ELV, TRIAC, 0-10V	10 7/8" x 3 7/8" x 1 3/8"

Accessory (Sold Separately)	Model	Description
	R1A-TOOL	Tool for angle adjustment and removal of trim and light engine

Downlight Trimless Luminaire (Required)	Model	Max Lumens	Max CBCP	Beam	Finish	Downlight Black	Downlight Gold	Downlight Haze	Downlight White
	R1ARDL Round, Downlight Wet Location	1095	3375	26° 36° 55°	BK Black GL Gold HZ Haze WT White				
	R1ASDL Square, Downlight Wet Location	1085	3350	26° 36° 55°	BK Black GL Gold HZ Haze WT White				

Pinhole Trimless Luminaire (Required)	Model	Max Lumens	Max CBCP	Beam	Finishes	Pinhole Black	Pinhole White
	R1ARPL Round, Pinhole Wet Location	570	2105	26° 32°	BK Black WT White		
	R1ASPL Square, Pinhole Wet Location	665	2710	26° 32°	BK Black WT White		

Adjustable Trimless Luminaire (Required)	Model	Max Lumens	Max CBCP	Beam	Finishes	Adjustable Black	Adjustable Gold	Adjustable Haze	Adjustable White
	R1ARAL Round, Adjustable Damp Location	1090	3505	26° 36° 55°	BK Black GL Gold HZ Haze WT White				
	R1ASAL Square, Adjustable Damp Location	1050	3370	26° 36° 55°	BK Black GL Gold HZ Haze WT White				

Wall Wash Trimless Luminaire (Required)	Model	Max Lumens	Max CBCP	Beam	Finishes	Wall Wash Black	Wall Wash White
	R1ARWL Round, Wall Wash Wet Location	600	N/A	Asym	BK Black WT White		
	R1ASWL Square, Wall Wash Wet Location	635	N/A	Asym	BK Black WT White		

Housing for Downlight, Pinhole, Wall Wash Trimless (Required)	Model	Power	Color Temp	CRI
	R1ARRL Round IC Rated, Airtight	11W	927 2700K	90
			930 3000K	90
			935 3500K	90
			940 4000K	90
			WD 3000K - 1800K	90
	R1ASRL Square, IC Rated, Airtight	11W	927 2700K	90
			930 3000K	90
			935 3500K	90
			940 4000K	90
			WD 3000K - 1800K	90

Housing for Adjustable Trimless (Required)	Model	Power	Color Temp	CRI
	R1ARARL Round IC Rated, Airtight	11W	927 2700K	90
			930 3000K	90
			935 3500K	90
			940 4000K	90
			WD 3000K - 1800K	90
	R1ASARL Square, IC Rated, Airtight	11W	927 2700K	90
			930 3000K	90
			935 3500K	90
			940 4000K	90
			WD 3000K - 1800K	90

Frame-In Kit for New Construction Installation	Model
	R1ABFL Frame-In Kit

AETHER ATOMIC

DIMINUTIVE TRIM LED RECESSED



PATENT
PENDING

Power: 11W
Input: 600mA 18V DC
Dimming: 100% - 1% ELV, TRIAC (120V only), 0-10V, DMX
Rated Life: 50,000 hours
Ceiling Thickness: ½" - 2" (Wood), ½" - ¾" (Drywall & Grid)
Ceiling Cutout: 1¼" (Downlight & Wall Wash), 1⅝" (Adjustable)



DRYWALL CEILING

The trimmed version of this minuscule recessed luminaire installs neatly and easily into drywall architecture for a clean, minimalist look.

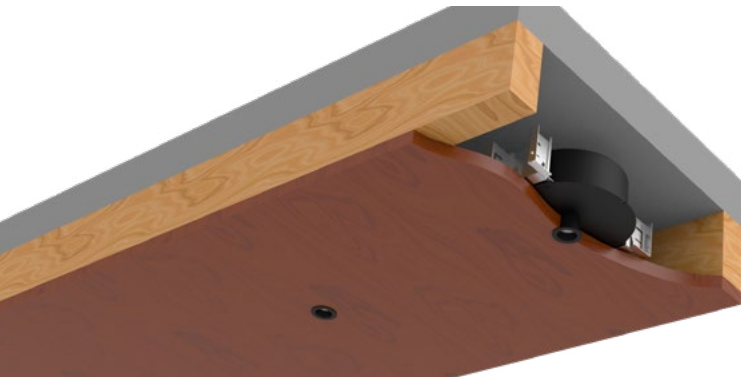

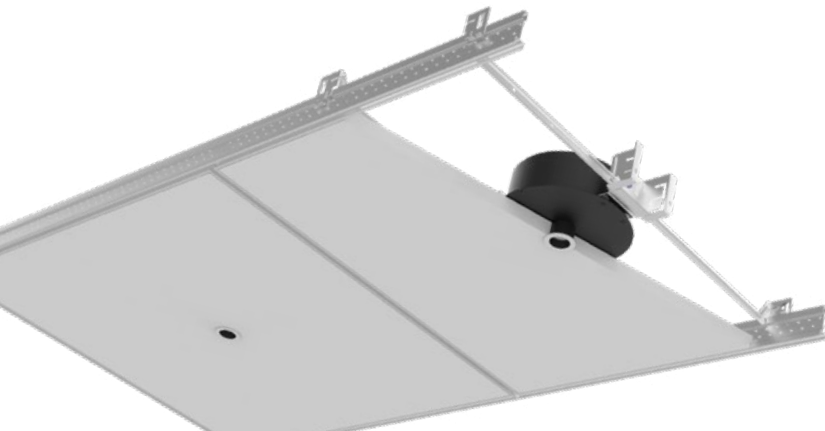

WOOD CEILING

Our premier, discreet recessed lighting family perfectly complements today's beautiful millwork ceilings with thoughtful design and high-quality optics.



GRID OR ACOUSTICAL CEILING TILE

An engineering marvel, our trimmed Aether Atomic luminaires add robust, quiet illumination to ACT environments.

Remote Power Supply (Required)	Model	Input	Output	Dimmable	Dimensions
	PS-0600A-UR1	120V - 277V	600mA 18V DC 1 Channel UL Class 2	100%-1% ELV, TRIAC, 0-10V	8¾" x 2" x 1¾"
	PS-0600A-UR6	120V - 277V	600mA 18V DC 6 Channel UL Class 2	100%-1% ELV, TRIAC, 0-10V	10⅞" x 3⅞" x 1⅝"

Accessory (Sold Separately)	Model	Description
	R1A-TOOL	Tool for angle adjustment and removal of trim and light engine

Downlight Trim Luminaire (Required)	Model	Max Lumens	Max CBCP	Beam	Finishes	Downlight Black	Downlight Black/White	Downlight Gold/White	Downlight Haze/White	Downlight White
	R1ARDT Round, Downlight Wet Location	1095	3375	26° 36° 55°	BK Black BKWT Black/White GLWT Gold/White HZWT Haze/White WT White					
	R1ASDT Square, Downlight Wet Location	1085	3350	26° 36° 55°	BK Black BKWT Black/White GLWT Gold/White HZWT Haze/White WT White					

Pinhole Trim Luminaire (Required)	Model	Max Lumens	Max CBCP	Beam	Finishes	Pinhole Black	Pinhole White
	R1ARPT Round, Pinhole Wet Location	570	2105	26° 32°	BK Black WT White		
	R1ASPT Square, Pinhole Wet Location	665	2710	26° 32°	BK Black WT White		

Adjustable Trim Luminaire (Required)	Model	Max Lumens	Max CBCP	Beam	Finishes	Adjustable Black	Adjustable Black/White	Adjustable Gold/White	Adjustable Haze/White	Adjustable White
	R1ARAT Round, Adjustable Damp Location	1090	3505	26° 36° 55°	BK Black BKWT Black/White GLWT Gold/White HZWT Haze/White WT White					
	R1ASAT Square, Adjustable Damp Location	1050	3370	26° 36° 55°	BK Black BKWT Black/White GLWT Gold/White HZWT Haze/White WT White					

Wall Wash Trim Luminaire (Required)	Model	Max Lumens	Max CBCP	Beam	Finishes	Wall Wash Black	Wall Wash White
	R1ARWT Round, Wall Wash Wet Location	600	N/A	Asym	BK Black WT White		
	R1ASWT Square, Wall Wash Wet Location	635	N/A	Asym	BK Black WT White		

Housing for Downlight, Pinhole, Wall Wash Trim (Required)	Model	Power	Color Temp	CRI	
	R1ARNT Round IC Rated, Airtight	11W	927	2700K	90
			930	3000K	90
			935	3500K	90
			940	4000K	90
			WD	3000K - 1800K	90
	R1ASNT Square, IC Rated, Airtight	11W	927	2700K	90
			930	3000K	90
			935	3500K	90
			940	4000K	90
			WD	3000K - 1800K	90

Housing for Adjustable Trim (Required)	Model	Power	Color Temp	CRI	
	R1ARANT Round IC Rated, Airtight	11W	927	2700K	90
			930	3000K	90
			935	3500K	90
			940	4000K	90
			WD	3000K - 1800K	90
	R1ASANT Square, IC Rated, Airtight	11W	927	2700K	90
			930	3000K	90
			935	3500K	90
			940	4000K	90
			WD	3000K - 1800K	90

AETHER 2"

EXTREME SHALLOW AIRTIGHT LED RECESSED



CALIFORNIA
JA8
TITLE 24



PATENT
PENDING

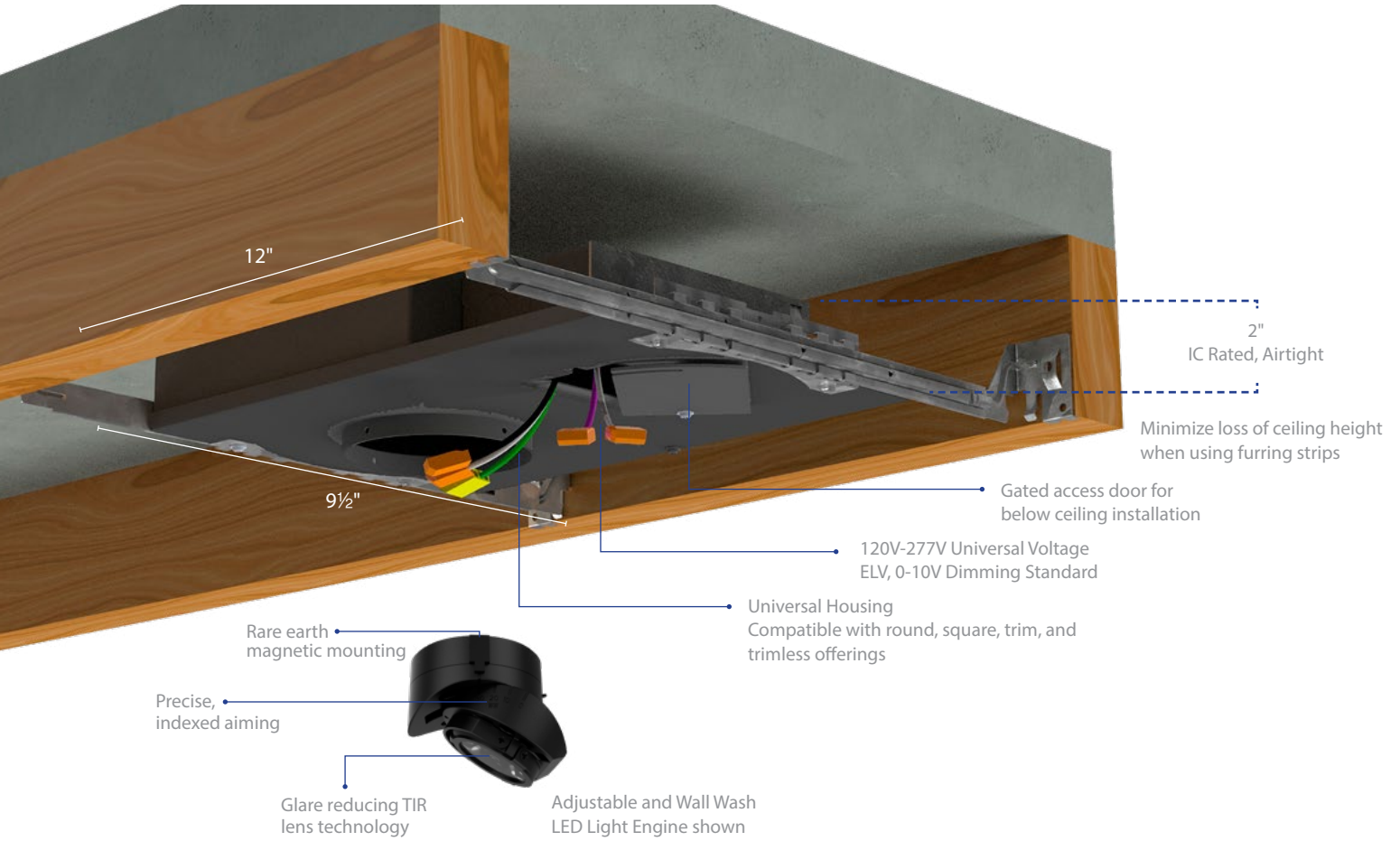

LIGHT ENGINE

TRIM

TRIMLESS

DOWNLIGHT

General Illumination
Superior Glare Control



0-30° ADJUSTABLE

Low Glare Accenting Illumination
Lensed, Wet Location Option Available

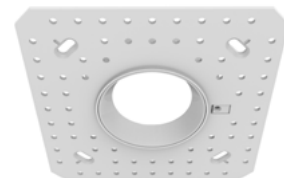

WALL WASH

Wall Illumination
Innovative Patterned Lens





AETHER 2"

EXTREME SHALLOW TRIM LED RECESSED

Input: 120V-277V
 Comparable to: 75W MR16
 Dimming: 100% - 5% ELV, TRIAC, 100% - 5%, 0-10V
 Rated Life: 50,000 hours



Trim (Order Housing Separately)	Model	Beam	Max Lumens	Max CBCP	Color Temp	CRI	Finish
 Round, Downlight Lensed, Wet Location Dimensions: 2 5/8" (width), 4 1/8" (depth)	 R2ARDT Round, Downlight Lensed, Wet Location	S 17° N 24° F 40° W 50°	1335	6500	827 2700K 85	85	BK Black BKWT Black/White HZWT Haze/ White WT White
					830 3000K 85		
					835 3500K 85		
 Square, Downlight Lensed, Wet Location Dimensions: 2 3/8" (width), 4 1/8" (depth)	 R2ASDT Square, Downlight Lensed, Wet Location				927 2700K 90	90	
					930 3000K 90		
 Round, 0-30° Adjustable Damp Location Dimensions: 2 5/8" (width), 4 1/8" (depth)	 R2ARAT Round, 0-30° Adjustable Damp Location	N 26° F 40°	1400	4675	827 2700K 85	85	BK Black BKWT Black/White HZWT Haze/ White WT White
					830 3000K 85		
					835 3500K 85		
 Square, 0-30° Adjustable Damp Location Dimensions: 2 3/8" (width), 4 1/8" (depth)	 R2ASAT Square, 0-30° Adjustable Damp Location				927 2700K 90	90	
					930 3000K 90		
 Round, 0-25° Adjustable Lensed, Wet Location Dimensions: 2 5/8" (width), 4 1/8" (depth)	 R2ARAT Round, 0-25° Adjustable Lensed, Wet Location	N 28° F 40°	1290	4030	827 2700K 85	85	LBK Black LBKWT Black/White LHZWT Haze/ White LWT White
					830 3000K 85		
					835 3500K 85		
 Square, 0-25° Adjustable Lensed, Wet Location Dimensions: 2 3/8" (width), 4 1/8" (depth)	 R2ASAT Square, 0-25° Adjustable Lensed, Wet Location				927 2700K 90	90	
					930 3000K 90		
 Round, Wall Wash Lensed, Wet Location Dimensions: 2 5/8" (width), 1/4" (height), 4 1/8" (depth)	 R2ARWT Round, Wall Wash Lensed, Wet Location	A Asym	1095	N/A	827 2700K 85	85	BK Black BKWT Black/White HZWT Haze/ White WT White
					830 3000K 85		
					835 3500K 85		
 Square, Wall Wash Lensed, Wet Location Dimensions: 2 3/8" (width), 1/4" (height), 4 1/8" (depth)	 R2ASWT Square, Wall Wash Lensed, Wet Location				927 2700K 90	90	
					930 3000K 90		

Example: **R2ARWT-A930-WT**

Housing (Order Trim Separately)	Model
 Dimensions: 2 1/2" (width), 4" (depth), 23 1/2" max. (length), 7 1/16" (length)	HR-2LED-R10A Remodel (9W) IC Rated, Airtight
 Dimensions: 2 1/2" (width), 4" (depth), 23 1/2" max. (length), 7 1/16" (length), 1 1/2" (height)	HR-2LED-R15A Remodel (15W) Non-IC Rated, Airtight
 Dimensions: 3 5/8" (width), 1/2" (height), 8 3/8" (height), 11 3/4" (width), 14 3/8" (width), Min 9 1/2" (height), Max 24 1/2" (height)	HR-2LED-H13A New Construction (15W) IC Rated, Airtight
	HR-2LED-H13AC New Construction (15W) IC Rated, Airtight Chicago Plenum Rated

AETHER 2"

EXTREME SHALLOW TRIMLESS LED RECESSED

Input: 120V-277V
 Comparable to: 75W MR16
 Dimming: 100% - 5% ELV, TRIAC, 100% - 5%, 0-10V
 Rated Life: 50,000 hours



Trimless (Order Housing Separately)	Model	Beam	Max Lumens	Max CBCP	Color Temp	CRI	Finish
		R2ARDL Round, Downlight Lensed, Wet Location	S 17° N 24° F 40° W 50°	1335 6500	827 2700K 85 830 3000K 85 835 3500K 85 840 4000K 85	85 85 85 85	BK Black HZ Haze WT White
					927 2700K 90 930 3000K 90		
		R2ASDL Square, Downlight Lensed, Wet Location			927 2700K 90 930 3000K 90	90 90	
		R2ARAL Round, 0-30° Adjustable Damp Location	N 26° F 40°	1400 4675	827 2700K 85 830 3000K 85 835 3500K 85 840 4000K 85	85 85 85 85	BK Black HZ Haze WT White
					927 2700K 90 930 3000K 90		
		R2ASAL Square, 0-30° Adjustable Damp Location			927 2700K 90 930 3000K 90	90 90	
		R2ARAL Round, 0-25° Adjustable Lensed, Wet Location	N 28° F 40°	1290 4030	827 2700K 85 830 3000K 85 835 3500K 85 840 4000K 85	85 85 85 85	LBK Black LHZ Haze LWT White
					927 2700K 90 930 3000K 90		
		R2ASAL Square, 0-25° Adjustable Lensed, Wet Location			927 2700K 90 930 3000K 90	90 90	
		R2ARWL Round, Wall Wash Lensed, Wet Location	A Asym	1095 N/A	827 2700K 85 830 3000K 85 835 3500K 85 840 4000K 85	85 85 85 85	BK Black BKWT Black/White HZWT Haze/White WT White
					927 2700K 90 930 3000K 90		
		R2ASWL Square, Wall Wash Lensed, Wet Location			927 2700K 90 930 3000K 90	90 90	

Example: **R2ARWL-A930-WT**

Housing (Order Trim Separately)

Model

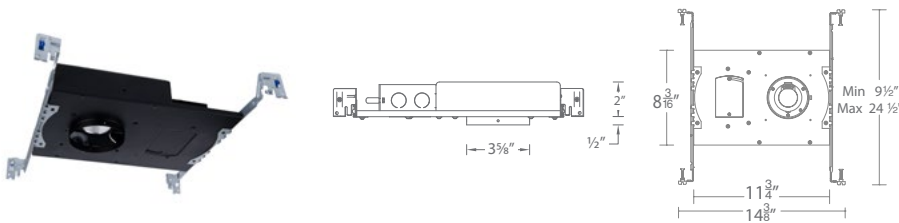

HR-2LED-H13A	New Construction (15W) IC Rated, Airtight
HR-2LED-H13AC	New Construction (15W) IC Rated, Airtight Chicago Plenum Rated



א.כ.צ.ה. ת.ל.מ.ו. ש.ח.י. 11 75	ת.כ. פ.ת.ו.א.מ.י.א.ח.א. 11 75	א.כ.צ.ה. ת.ל.מ.ו. ש.ח.י. 11 75	ת.כ. פ.ת.ו.א.מ.י.א.ח.א. 11 75
ח.ל.ו.ס. ת.ל.מ.ו. 11 29	ח.ל.ו.ס. ת.ל.מ.ו. 11 29	ח.ל.ו.ס. ת.ל.מ.ו. 11 29	ח.ל.ו.ס. ת.ל.מ.ו. 11 29
ח.ל.ו.ס. ת.ל.מ.ו. 11 29	ח.ל.ו.ס. ת.ל.מ.ו. 11 29	ח.ל.ו.ס. ת.ל.מ.ו. 11 29	ח.ל.ו.ס. ת.ל.מ.ו. 11 29
ח.ל.ו.ס. ת.ל.מ.ו. 11 29	ח.ל.ו.ס. ת.ל.מ.ו. 11 29	ח.ל.ו.ס. ת.ל.מ.ו. 11 29	ח.ל.ו.ס. ת.ל.מ.ו. 11 29
ח.ל.ו.ס. ת.ל.מ.ו. 11 29	ח.ל.ו.ס. ת.ל.מ.ו. 11 29	ח.ל.ו.ס. ת.ל.מ.ו. 11 29	ח.ל.ו.ס. ת.ל.מ.ו. 11 29
ח.ל.ו.ס. ת.ל.מ.ו. 11 29	ח.ל.ו.ס. ת.ל.מ.ו. 11 29	ח.ל.ו.ס. ת.ל.מ.ו. 11 29	ח.ל.ו.ס. ת.ל.מ.ו. 11 29
ח.ל.ו.ס. ת.ל.מ.ו. 11 29	ח.ל.ו.ס. ת.ל.מ.ו. 11 29	ח.ל.ו.ס. ת.ל.מ.ו. 11 29	ח.ל.ו.ס. ת.ל.מ.ו. 11 29
ח.ל.ו.ס. ת.ל.מ.ו. 11 29	ח.ל.ו.ס. ת.ל.מ.ו. 11 29	ח.ל.ו.ס. ת.ל.מ.ו. 11 29	ח.ל.ו.ס. ת.ל.מ.ו. 11 29
ח.ל.ו.ס. ת.ל.מ.ו. 11 29	ח.ל.ו.ס. ת.ל.מ.ו. 11 29	ח.ל.ו.ס. ת.ל.מ.ו. 11 29	ח.ל.ו.ס. ת.ל.מ.ו. 11 29
ח.ל.ו.ס. ת.ל.מ.ו. 11 29	ח.ל.ו.ס. ת.ל.מ.ו. 11 29	ח.ל.ו.ס. ת.ל.מ.ו. 11 29	ח.ל.ו.ס. ת.ל.מ.ו. 11 29



TRACK + MONOPOINT

The Ocularc family sets the standard for residential, commercial, and hospitality applications. Featuring high-output LED technology, an integral driver and beam angle options, Ocularc delivers a versatile design that complements virtually any décor.

The track system offers flexibility within the space, while monopoint installations provide a clean install for singular heads. The new Ocularc family comes equipped with a convenient all-in-one 5 CCT select switch, allowing for color temperature adjustments with ease.

OCULARC 7011



- Integrated 5CCT Switch: 2700K, 3000K, 3500K, 4000K, 5000K
- Integral driver and high output COB LED
- 350° horizontal and 90° vertical aiming
- Three interchangeable beam options included:
60° beam film pre-installed
30° film supplied
17° spot beam, remove all films

Power: 11W
Input: 120V
Comparable to: 65W MR16
Dimming: 100% - 10% ELV, TRIAC
Rated Life: 50,000 hours

CCT Selection Switch Onboard



OCULARC TRACK PACK 7011/3



- Track pack includes:
- 4ft H-Track
 - Floating Canopy
 - Three 7011-CS Ocularc Track Heads



System	Model	Color Temp	CRI	Beam	Max Lumens	Max CBCP	Finish
	7011	2700K	90	17°	1025	3935	BK Black
		3000K		30°			BN Brushed Nickel
		3500K		60°			DB Dark Bronze*
		4000K					WT White
		5000K					
Example: H-7011-CS-DB							
*Only available in H Track							
System	Model	Color Temp	CRI	Beam	Max Lumens	Max CBCP	Finish
	7011/3	2700K	90	17°	1025 x3	3935 x3	BK Black
		3000K		30°			WT White
		3500K		60°			
		4000K					
		5000K					
Example: H-7011/3-CS-WT							

REPLACEMENT OPTICS

- FILM-16-N** Narrow Flood Optic
- FILM-16-F** Flood Optic

INTERCHANGEABLE BEAM OPTIONS:

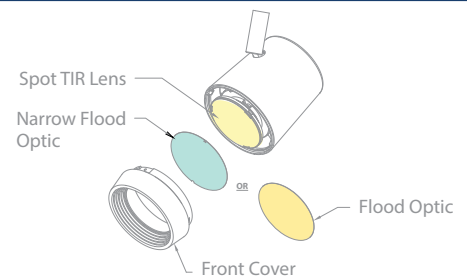

OCULARC 7030



- Integrated 5CCT Switch: 2700K, 3000K, 3500K, 4000K, 5000K
- Integral driver and high output COB LED
- 350° horizontal and 90° vertical aiming
- Accommodates one lens accessory and one glare control accessory
- Three interchangeable beam options included:
 - 55° beam film pre-installed
 - 40° film supplied
 - 20° spot beam, remove all films

Power: 29W
Input: 120V
Comparable to: 100W PAR38
Dimming: 100% - 10% ELV, TRIAC
Rated Life: 50,000 hours

CCT Selection Switch Onboard

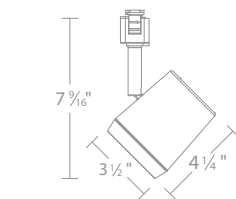
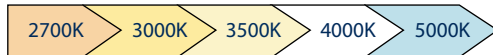

System	Model	Color Temp	CRI	Beam	Max Lumens	Max CBCP	Finish
H	H Track	2700K					BK Black
L	L Track	3000K		20°	2255	9300	BN Brushed Nickel
J	J/J2 Track	3500K	90	40°	2095	2830	DB Dark Bronze*
		4000K		55°	2065	1870	WT White
		5000K					<i>*Only available in H Track</i>

Example: **H-7030-CS-BN**

REPLACEMENT OPTICS

- FILM-20-N Narrow Flood Optic
- FILM-20-F Flood Optic

LENS ACCESSORIES

- LENS-20-AMB Amber
- LENS-20-BLU Blue
- LENS-20-GRN Green
- LENS-20-RED Red
- LENS-20-FR Frosted
- LENS-20-SPR Spread
- LENS-20-BEL Beam Elongating

GLARE CONTROL ACCESSORIES

- LENS-20P-CRL-BK
- LENS-20P-CRL-BN Cross Louver
- LENS-20P-CRL-WT
- LENS-20-SNOOT-BK
- LENS-20-SNOOT-BN Snoot
- LENS-20-SNOOT-WT
- LENS-20-HCL Honeycomb Louver

INTERCHANGEABLE BEAM OPTIONS:

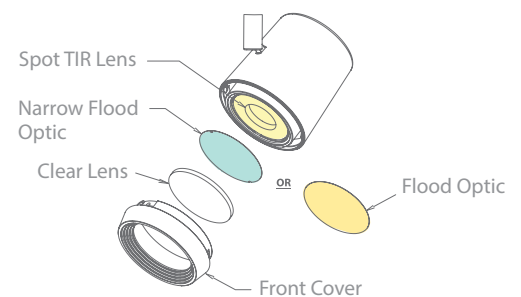

OCULARC 7012



- Integrated 5CCT Switch: 2700K, 3000K, 3500K, 4000K, 5000K
- Integral driver and high output COB LED
- 350° horizontal and 90° vertical aiming
- Three interchangeable beam options included:
 - 60° beam film pre-installed
 - 30° film supplied
 - 17° spot beam, remove all films

Power: 11W
Input: 120V
Comparable to: 65W MR16
Dimming: 100% - 10% ELV, TRIAC
Rated Life: 50,000 hours

CCT Selection Switch Onboard



System		Model	Color Temp	CRI	Beam	Max Lumens	Max CBCP	Finish	
	H	H Track	2700K						
	L	L Track	3000K		17°	1025	3935	BK	Black
	J	J/J2 Track	3500K	90	30°	955	1520		
			4000K		60°	920	670	WT	White
			5000K						
		7012	CS						
		Example: H-7012-CS-BK							

REPLACEMENT OPTICS

- FILM-15-N Narrow Flood Optic
- FILM-15-F Flood Optic

INTERCHANGEABLE BEAM OPTIONS:

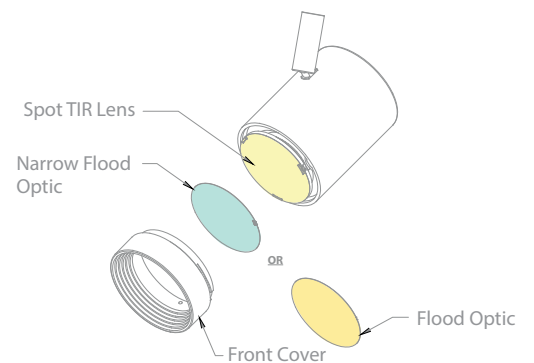

OCULARC 7013



- Integrated 5CCT Switch: 2700K, 3000K, 3500K, 4000K, 5000K
- Integral driver and high output COB LED
- 350° horizontal and 90° vertical aiming
- Three interchangeable beam options included:
 - 60° beam film pre-installed
 - 30° film supplied
 - 17° spot beam, remove all films

Power: 11W
Input: 120V
Comparable to: 65W MR16
Dimming: 100% - 10% ELV, TRIAC
Rated Life: 50,000 hours

CCT Selection Switch Onboard



	System	Model	Color Temp	CRI	Beam	Max Lumens	Max CBCP	Finish
	H	H Track	2700K					
	L	L Track	3000K		17°	1000	3200	BK Black
	J	J/J2 Track	3500K	7013	90	920	1365	WT White
			4000K	CS	60°	890	640	
			5000K					

Example: **H-7013-CS-WT**

REPLACEMENT OPTICS

- FILM-14-N Narrow Flood Optic
- FILM-14-F Flood Optic

INTERCHANGEABLE BEAM OPTIONS:

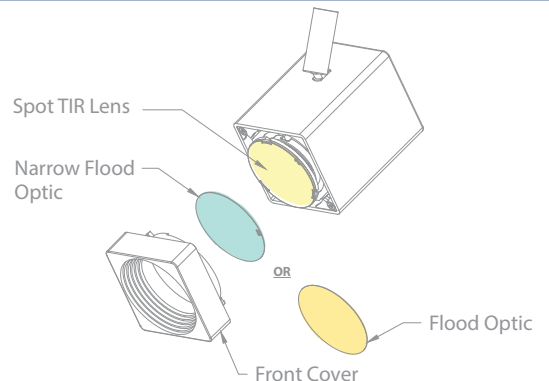

OCULARC 3020W



Power: 22W
Input: 120V
Comparable to: 20W HID
Dimming: 100%-10% ELV, TRIAC
Rated Life: 50,000 hours

- Install 3 to 5 feet from wall and 3 to 5 feet on center for optimal effect
- Integrated 5CCT Switch: 2700K, 3000K, 3500K, 4000K, 5000K
- Die-cast aluminum construction
- Powder-coated finishes
- Asymmetrical beam distribution for even wall illumination
- Economical performance luminaire with integral LED and driver

CCT Selection Switch Onboard

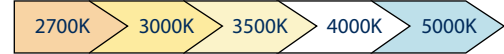

5 CCT Switch

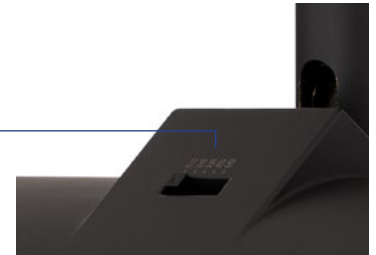

		System	Model	Color Temp	CRI	Max Lumens	Finish
	H	H Track	3020W	2700K	90	1150	BK Black WT White
	L	L Track		3000K			
	J	J/J2 Track		3500K			
				4000K			
				5000K			

Example: **H-3020W-CS-BK**

OCULARC MO-3020W



Power: 22W
Input: 120 - 277VAC
Comparable to: 20W HID
Dimming: 100%-10% ELV, TRIAC
Rated Life: 50,000 hours

- Install 3 to 5 feet from wall and 3 to 5 feet on center for optimal effect
- Integrated 5CCT Switch: 2700K, 3000K, 3500K, 4000K, 5000K
- Die-cast aluminium construction
- Powder-coated finishes
- Asymmetrical beam distribution for even wall illumination
- Economical performance luminaire with integral LED and driver



TRACK + MONOPOINT

CCT Selection Switch Onboard



	Model	Color Temp	CRI	Max Lumens	Finish
	MO-3020W	2700K	90	1150	BK Black WT White
		3000K			
		3500K			
		4000K			
		5000K			
	Example: MO-3020W-CS-BK				

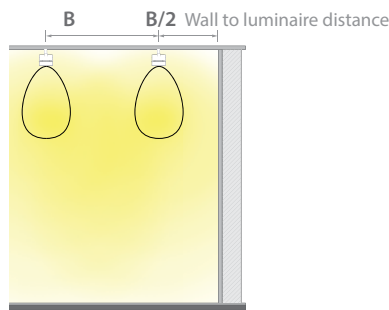
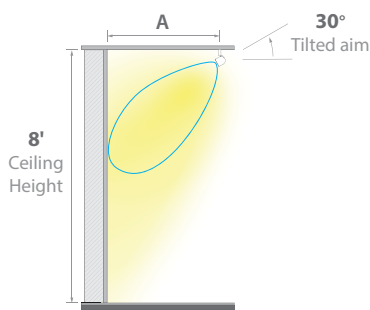

AVERAGE WALL ILLUMINANCE

	A Distance from wall	B On-center spacing distance	
		3 feet	5 feet
	3 feet	33 fc	21 fc
	5 feet	25 fc	16 fc

80% ceiling, 50% wall, 20% floor reflectance levels used in study. Changes to reflectance levels will affect results. Fixtures at 5000K.

EXTENSIONS *Custom order as a complete unit*

X6	6"	MO3020W	CS	BK WT
X12	12"			
X18	18"			
X24	24"			
X36	36"			
X48	48"			

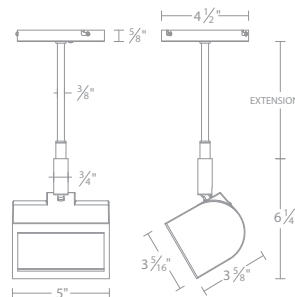

Example: X24-MO3020WCSWT



INVISILED®

InvisILED Lite+

Our basic line of LED tape is specially rated for storage areas, including closets and other spaces for long-term usage. It is an innovative tape light upgraded from our previous selections you have known and loved for nearly two decades.

Lumens:	150 lm/ft	Field-Cuttable:	Every 2"
Color Temp:	2200K, 2700K, 3000K, 3500K, 4500K	Max Run:	40'

InvisILED Pro+

Building on the foundation of our reliable tape system with the same trusted plug-and-play pin connectors and drivers, this tape is upgraded with Chip-on-Board LEDs to create seamless, white, continuous lighting. This professional-grade white tape light delivers optimal color consistency and brightness with a high 90-plus color rendering index (CRI) and a clean architectural look. It is an ideal dimmable system for task and accent lighting applications.

Lumens:	200 lm/ft	Field-Cuttable:	Every 2"
Color Temp:	2200K, 2700K, 3000K, 3500K, 4500K	Max Run:	33'

InvisILED Pro 2+

Flexible and easy to install, this high-performing, modern lighting tape offers robust, eco-friendly illumination using energy-efficient technology and a long-lasting design with non-toxic materials for environmental safety. This low-profile tape light uses minimal power consumption to lower energy costs and fits seamlessly under cabinets, in coves, and toe-kick spaces in residential, hospitality, and commercial environments. With multiple aluminum channel options, it is perfect for customizing lighting designs for your needs.

Lumens:	300 lm/ft	Field-Cuttable:	Every 2"
Color Temp:	2200K, 2700K, 3000K, 3500K, 4500K	Max Run:	25'



INVISIBLE LITE+ DAMP RATED 150 LM/FT TAPE LIGHT



- Specially rated for installation in storage areas of a clothes closet
- UV stabilized coating protects LEDs and circuitry for long term use in damp locations
- May be field cut every 2" at the end of a run
- Includes an end cap
- Max run length of 40' with 96W power supply
- 2 conductors wire between tape and power supply

Power: 2.2W / ft
Lumens: 150 lm / ft
CRI: 90+
Rated Life: 50,000 hours

Tape Selections	Model	Color Temp	Length	Quantity	Finish
	LED-TA24	22 2200K 27 2700K 30 3000K 35 3500K 45 4500K	2IN 2" 2IN-10 2" 1 1' 5 5' 1-40 1'	1 10 1 1 40	White
	Example: LED-TA2427-5				

"L" Connector	Model	Color Temp	Length	Finish
	LED-TA24	22 2200K 27 2700K 30 3000K 35 3500K 45 4500K	L	White
	Example: LED-TA2427-L			



INVISILED PRO+

DAMP RATED 200 LM/FT TAPE LIGHT

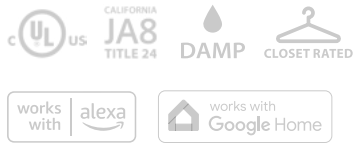

- Specially rated for installation in the storage area of a clothes closet
- Designed for bright cove or task lighting
- UV stabilized protective coating protects LEDs and circuitry for long term use in damp locations
- May be field cut every 2" at the end of a run
- Includes an end cap
- Maximum run length of 33' with 96W power supply
- 2 conductors wire between tape and power supply

Power: 2.9W / ft
Lumens: 200 lm / ft
CRI: 90+
Rated Life: 50,000 hours

Tape Selections	Model	Color Temp	Length	Quantity	Finish
	LED-TB24	22 2200K	2IN 2"	1	White
		27 2700K	2IN-10 2"	10	
		30 3000K	1 1'	1	
		35 3500K	5 5'	1	
		45 4500K	1-40 1'	40	

Example: **LED-TB2427-5**

"L" Connector	Model	Color Temp	Length	Finish
	LED-TB24	22 2200K	L	White
		27 2700K		
		30 3000K		
		35 3500K		
		45 4500K		

Example: **LED-TB2427-L**



INVISILED PRO 2+

DAMP RATED 300 LM/FT TAPE LIGHT



- Specially rated for installation in the storage area of a clothes closet
- UV stabilized protective coating protects LEDs and circuitry for long term use in damp locations
- May be field cut every 2" at the end of a run
- Includes an end cap
- Max run length of 25' with 96W power supply
- 2 conductors wire between tape and power supply

Power: 4.1W / ft
 Lumens: 300 lm / ft
 CRI: 90+
 Rated Life: 50,000 hours







Tape Selections	Model	Color Temp	Length	Quantity	Finish
	LED-TC24	22 2200K	2IN 2"	1	White
		27 2700K	2IN-10 2"	10	
		30 3000K	1 1'	1	
		35 3500K	1-40 1'	40	
		45 4500K	5 5'	1	

Example: **LED-TC2427-5**

"L" Connector	Model	Color Temp	Length	Finish
	LED-TC24	22 2200K	L	White
		27 2700K		
		30 3000K		
		35 3500K		
		45 4500K		

Example: **LED-TC2427-L**

COMPATIBLE CLASS 2 POWER SUPPLY (REQUIRED)

	Model		Input	Output	Dimming	Description
	EN-2460-RB2-T EN-24100-RB2-T	Remote	120VAC 120VAC	24VAC / 60W 24VAC / 96W	100%-5% ELV	Includes a 6' lead wire. UL Class 2 output.
	PS-24DC-U60R-T PS-24DC-U96R-T	Remote	120-277VAC	24VDC / 60W 24VDC / 96W	100%-5% ELV, TRIAC	Includes a 6' lead wire. UL Class 2 output.
	PS-24DC-U3X96R-T	Remote	120-277VAC	24VDC / 3 x 96W	100%-5% ELV, TRIAC, 0-10V	Includes 3 x 6' lead wires, 3 output channels, UL Class 2 output.
	EN-24100-277-RB2-T	Remote	277VAC	24VDC / 96W	100%-5% 0-10V	Includes a 6' lead wire. UL Class 2 output.
	EN-2460-P-AR-T EN-24100-P-AR-T	Plug-in	120VAC 120VAC	24VAC / 60W 24VAC / 96W	Non Dimmable	Includes a 6' lead wire. UL Class 2 output.
	EN-D24100-120-R	Wall Dimmer & Driver	120VAC	24VDC / 96W	Integral	Includes a 6' lead wire. UL Class 2 output.

SMART CONTROL

	Model	Description
	CT-96-SM	Includes a 96W 24VDC Power Supply (EN-24DC096-UNV-RB2), wireless controller (CTR-WDMX-24VDC) and a ready-to-connect lead wire with an InvisiLED Connector (LED-TC-B-2-WT) <i>Optional WallStation available on website.</i>

Transform your interiors with the InvisiLED® Smart Home Kit, designed exclusively for InvisiLED Lite+, Pro+, Pro 2+ and Pro 3 Tape. Crafted to simplify your life and elevate your everyday lighting experience, control your LED tape seamlessly via Wi-Fi using the MyWAC app with devices you already own, including Amazon Alexa and Google Home. Offers on/off activation and up/down dimming capability for 24VDC systems and high-output tape lighting applications. Or use DMX to control your popular control platforms.

EXAMPLE INSTALLATION FOR WIRELESS AND DMX CONTROL

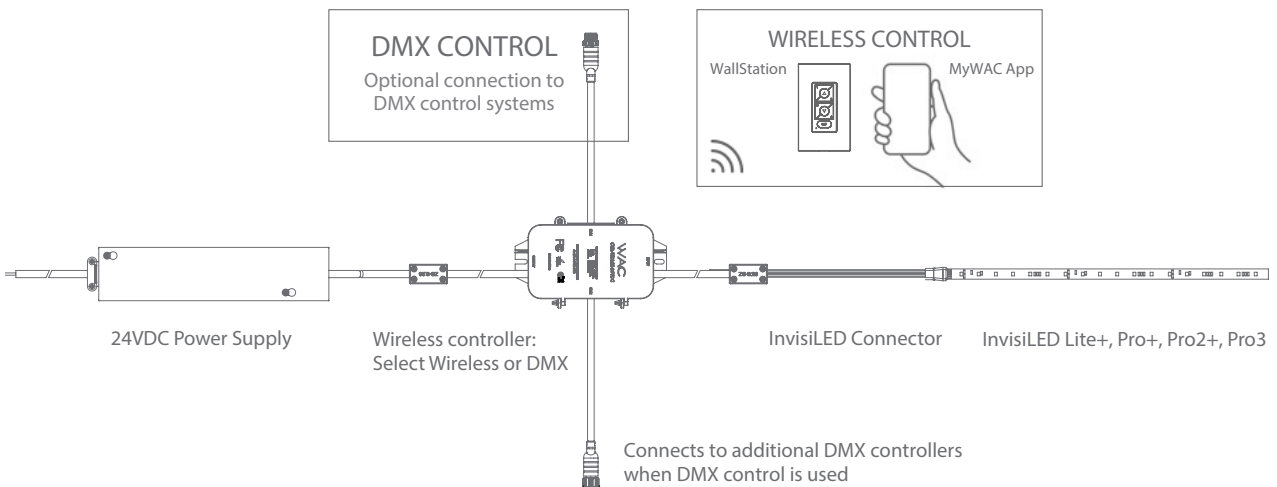

TRIMLESS RECESSED SLIM CHANNEL

Indoor InvisiLED tape

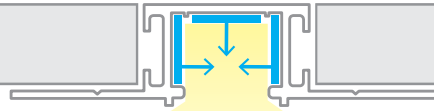

- Installs within 5/8" drywall depth
- Linear channel can be field cut
- Accommodates either one or two runs of InvisiLED indoor tape
- Includes a frosted acrylic diffuser

8FT LINEAR CHANNEL LED-T-RCH4-WT

Includes: 1 frosted diffuser
8 perforated metal sheets

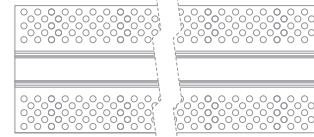
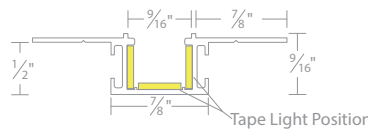

POWER FEED LED-T-RBOX4-WT

The end cap may be placed on either side.
Hanger bars may be installed on any side of the wiring box.

- Includes:
- 1 wiring box
 - 2 hanger bars
 - 2 end caps
 - 2 channel connectors
 - 1 counter sink drill bit
 - 1 drill bit
 - 2 power to tape connectors

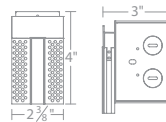
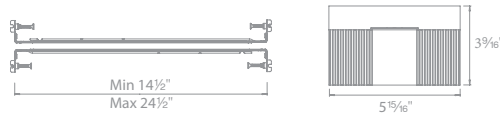

TRIMMED RECESSED SLIM CHANNEL

Indoor InvisiLED tape

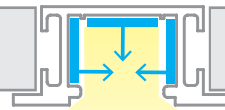

- Installs within 5/8" drywall depth
- Linear channel can be field cut
- Accommodates either one or two runs of InvisiLED indoor tape
- Includes a frosted acrylic diffuser

8FT LINEAR CHANNEL LED-T-RCH5-BK LED-T-RCH5-WT LED-T-RCH5-AL

Includes: 1 frosted diffuser
8 perforated metal sheets

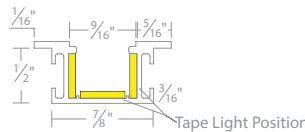

POWER FEED LED-T-RBOX5-BK LED-T-RBOX5-WT LED-T-RBOX5-AL

The end cap may be placed on either side.
Hanger bars may be installed on any side of the wiring box.

- Includes:
- 1 wiring box
 - 2 hanger bars
 - 2 end caps
 - 2 channel connectors
 - 1 counter sink drill bit
 - 1 drill bit
 - 2 power to tape connectors

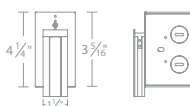
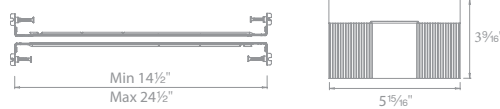

SYMMETRICAL RECESSED CHANNEL

Indoor InvisiLED tape

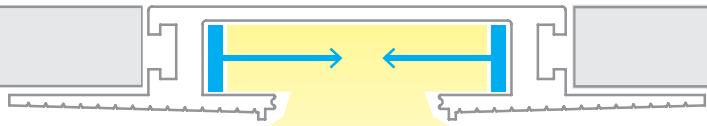

- Installs within 5/8" drywall depth
- Linear channel can be field cut
- Accommodates either one or two runs of InvisiLED indoor tape
- Includes a translucent white acrylic diffuser
- Dense foam insert to be removed in installation after spackling

8FT LINEAR CHANNEL LED-T-RCH1-WT

- Includes: 1 diffuser
8 perforated metal sheets

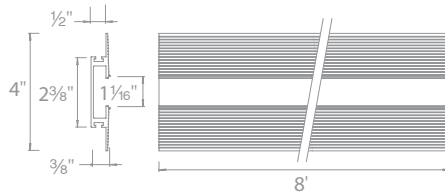

POWER FEED LED-T-RBOX1-WT

The end cap may be placed on either side.
Hanger bars may be installed on any side of the wiring box.

- Includes: 1 wiring box
2 hanger bars
4 five-pin InvisiLED® adapters
2 end caps
1 diffuser
2 channel connectors
1 counter sink drill bit
1 drill bit
1 installation tool

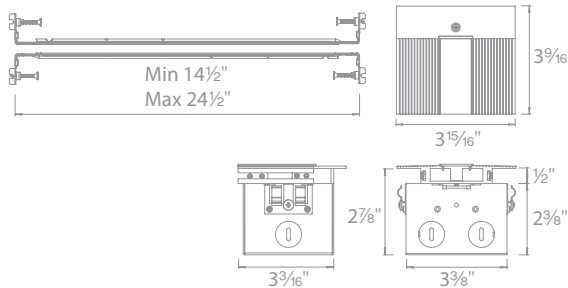

LATERAL CORNER LED-T-CTC1-WT

- Includes: 1 diffuser
2 channel connectors
2 perforated metal sheets

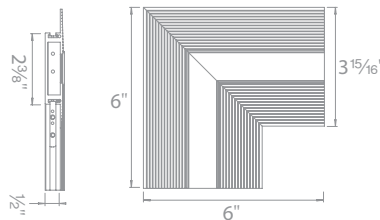

PERPENDICULAR CORNER LED-T-WTC1-WT

Transitions between walls or wall to ceiling

- Includes: 1 diffuser
2 channel connectors
2 perforated metal sheets

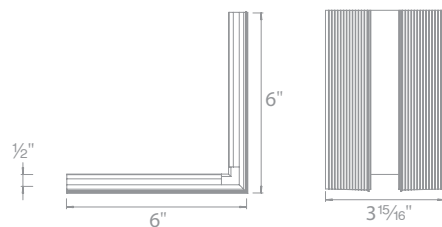

OUTSIDE CORNER LED-T-WTW1-WT

Transitions around columns, bump outs, or soffits

- Includes: 1 diffuser
2 channel connectors
2 perforated metal sheets

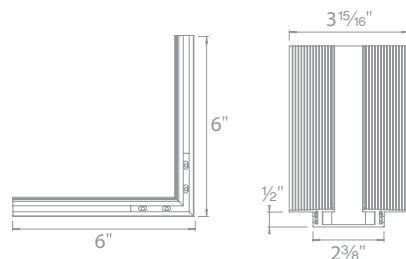

ASYMMETRICAL RECESSED CHANNEL

- Installs within $\frac{5}{8}$ " drywall depth
- Linear channel can be field cut
- Accommodates one run of InvisiLED indoor tape
- Dense foam insert to be removed in installation after spackling
- Recommended installation within 15 inches of surface to be illuminated

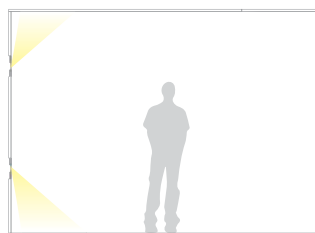

Indoor InvisiLED tape

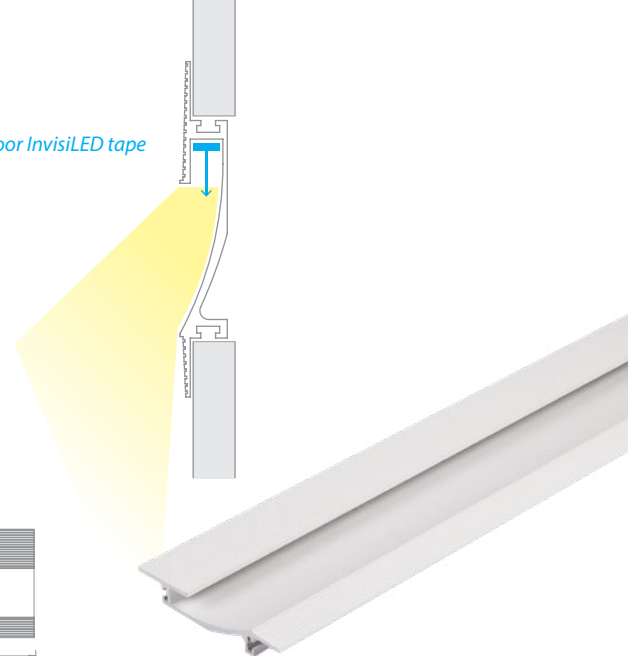

8FT LINEAR CHANNEL LED-T-RCH2-WT

Includes: 8 perforated metal sheets
2 channel connectors

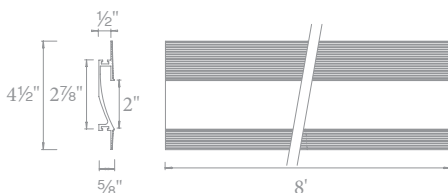

POWER FEED LED-T-RBOX2-WT

LED-T-RBOX2-WT

The end cap may be placed on either side. Hanger bars may be installed on any side of the wiring box.

Includes: 1 wiring box
2 hanger bars
2 five-pin InvisiLED® adapters
2 end caps (left and right)
2 channel connectors
1 counter sink bit
1 drill bit

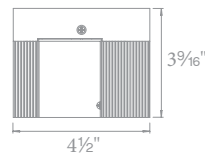
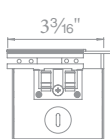

INDIRECT RECESSED CHANNEL

- Linear channel can be field cut
- Dense foam insert to be removed in installation after spackling
- Allows option to use different color InvisiLED in one channel and switch them separately

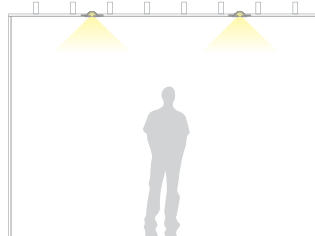

8FT LINEAR CHANNEL LED-T-RCH3-WT

Includes: 10 perforated metal sheets
2 channel connectors

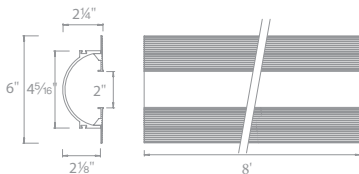

POWER FEED LED-T-RBOX3-WT

LED-T-RBOX3-WT

The end cap may be placed on either side.
Hanger bars may be installed on any side of the wiring box.

Includes: 1 wiring box
2 hanger bars
4 five-pin InvisiLED® adapters
1 end cap
2 channel connectors
1 counter sink drill bit
1 drill bit

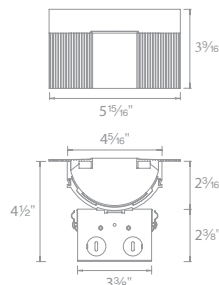
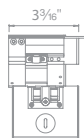



ANGLED RECESSED CHANNEL

Indoor InvisILED tape

- Recessed asymmetrical distribution provides a clean wash of illumination
- Linear channel can be field cut
- Accommodates one run of InvisILED indoor tape
- Includes a frosted acrylic diffuser



5FT LINEAR CHANNEL

- LED-T-CH6-BK
- LED-T-CH6-WT
- LED-T-CH6-AL

ADDITIONAL END CAPS

- LED-T-CH6-EC-BK
- LED-T-CH6-EC-WT
- LED-T-CH6-EC-AL

Includes: 1 frosted diffuser
2 end caps

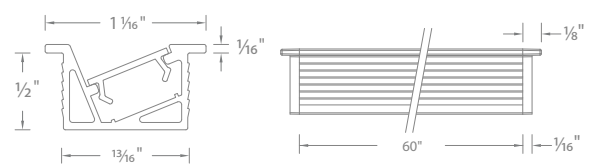

INDOOR ALUMINUM CHANNELS

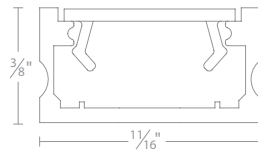

SHALLOW ALUMINUM CHANNEL LED-T-CH5-BK 5'
LED-T-CH5-WT
LED-T-CH5-AL

ADDITIONAL END CAPS LED-T-CH5-EC-BK 2 pcs
LED-T-CH5-EC-WT
LED-T-CH5-EC-AL

Includes a diffuser, 2 end caps, and 5 screws.

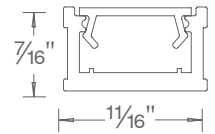

**ALUMINUM CHANNEL
ADDITIONAL END CAPS** LED-T-CH 5'
LED-T-CH-EC 2 pcs

Diffuses light from InvisiLED tape.
Includes a diffuser, 2 end caps, and 5 screws.

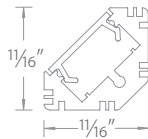

**45° ANGLED ALUMINUM CHANNEL
ADDITIONAL END CAPS** LED-T-CH2 5'
LED-T-CH2-EC 2 pcs

Includes a diffuser, 2 end caps, and 5 screws.

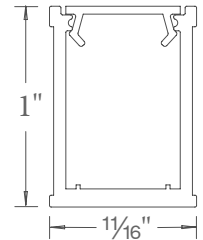

**DEEP ALUMINUM CHANNEL
ADDITIONAL END CAPS** LED-T-CH1 5'
LED-T-CH1-EC 2 pcs

Eliminates visible hot spots.
Includes a diffuser, 2 end caps, and 5 screws.

INDOOR MOUNTING ACCESSORIES

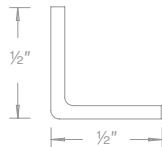

ALUMINUM RETROFIT CHANNEL LED-T-RC 3 feet

Can be bent to create fixed curves or used as a glare shield.

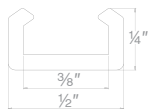

CLEAR CHANNEL LED-TO24-CH5 5 feet

Compatible with InvisiLED Lite+, Pro+, Pro2+ and Pro3 only.

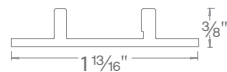

FIXED ANGLE CHANNEL CLIP LED-T-CL3-PT

Includes 2 pieces, 4 screws. Use to mount Aluminum Channel.



CLIP LED-T-CL

For surfaces that are difficult to adhere.
Includes: 10 pcs plastic clips and 10 pcs screws. Compatible with InvisiLED Lite+, Pro+, Pro2+ and Pro3 only.



CURVE CLIP LED-T-CL1

Clips to hold indoor InvisiLED tapes sections. Includes: 10 pcs plastic clips and 10 pcs screws. Compatible with InvisiLED Lite+, Pro+, Pro2+ and Pro3 only.

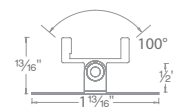

ADJUSTABLE CHANNEL CLIP LED-T-CL2-PT

Includes 2 pieces, 4 screws. Used to mount Aluminum Channel.
Adjust 50° from center either way.



OPTICAL CHANNELS AND LENS ACCESSORIES



FROSTED DIFFUSER

LED-T-CH5-COV-FR 5'
LED-T-CH8-COV-FR 8'

Standard diffuser included with channel.



**SPOT OPTIC DEEP CHANNEL
ADDITIONAL END CAPS**

LED-T-CH3-SP 5'
LED-T-CH1-EC 2 pcs

Eliminates visible hot spots.
Includes a diffuser, 2 end caps, and 5 screws.

Spot 9° Beam Angle



SEMI-CLEAR DIFFUSER

LED-T-CH5-COV-SF 5'
LED-T-CH8-COV-SF 8'

Optional diffuser available, order separately.

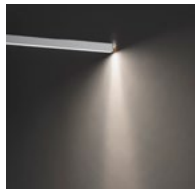

**FLOOD OPTIC DEEP CHANNEL
ADDITIONAL END CAPS**

LED-T-CH3-FL 5'
LED-T-CH1-EC 2 pcs

Eliminates visible hot spots.
Includes a diffuser, 2 end caps, and 5 screws.

Flood 54° Beam Angle



BLACK DIFFUSER

LED-T-CH5-COV-BK 5'
LED-T-CH8-COV-BK 8'

Optional diffuser available, order separately.



**WIDE FLOOD OPTIC DEEP CHANNEL
ADDITIONAL END CAPS**

LED-T-CH3-WF 5'
LED-T-CH1-EC 2 pcs

Eliminates visible hot spots.
Includes a diffuser, 2 end caps, and 5 screws.

Wide Flood 84° Beam Angle



CUT AND SECURELY RECONNECT WITH EASE



Input: 24VDC
Lumens: Up to 300 lm/ft
Rated Life: 50,000 hours



- Cut and re-connectable with secure screw terminal accessories
- May be cut every 2 inches
- Uniform illumination
- Seamless line of light

System	Lumens	Max Run	Wattage	Length	Length Description	Color Temp	CRI	Finish
T24-GE1	100+ lm/ft	40ft (60W), 40 ft (96W)	1.2W/ft	15	15 ft spool (incl. 2 pcs Tape to Tape Connector)	27 2700K	90	WT White
T24-GE2	200+ lm/ft	24ft (60W), 30ft (96W)	2.2W/ft	24	24 ft spool (incl. 4 pcs Tape to Tape Connector)	30 3000K		
T24-GE3	300+ lm/ft	15ft (60W), 24ft (96W)	3.9W/ft	100	100 ft spool (incl. 10 pcs Tape to Tape Connector)	35 3500K		
						40 4000K		

Example: **T24-GE3-15-27WT**



GEMINI KIT

This kit provides all the necessary components for seamless single-CCT linear lighting installations. Tailored for a quick and easy installation, these kits ensure optimal compatibility and an easy setup. Enhance your efficiency and eliminate guesswork with our curated installation kits, designed to deliver superior performance and reliability for any lighting project.





INCLUDES:

- Gemini Tape 300 24VDC 15ft
- Remote Power Supply 96W 24VDC
- In Wall Rated Extension Cable 12ft White
- Power to Tape connector 10 pcs
- Tape to Tape connector 3 pcs

System	Lumens	Max Run	Wattage	Length	Color Temp	CRI	Finish
T24-GE3-15-27KIT	300+ lm/ft	15ft (60W), 24ft (96W)	3.9W/ft	15 ft spool	2700K	90	White
T24-GE3-15-30KIT					3000K		
T24-GE3-15-35KIT					3500K		

Example: **T24-GE3-15-30KIT**







POWER SUPPLY

Type	Model	Dimension	Input	Output	Dimming
 <p>Portable power supply</p> <ul style="list-style-type: none"> • Include 6' lead wire • Integral on-off switch 	PS-24DC-60P-GE	4" x 2 ³ / ₁₆ " x 1 ¹ / ₂ "	120V	24VDC 60W	Non Dimmable
 <p>Remote power supply</p> <ul style="list-style-type: none"> • ELV Dimming 100%-10% • Include 6' lead wire 	EN-BT60-24*	6 ¹ / ₂ " x 2 ¹ / ₁₆ " x 1 ¹ / ₄ "	120V	24VDC 60W	ELV
	EN-BT96-24*	6 ¹ / ₂ " x 2 ¹ / ₁₆ " x 1 ¹ / ₄ "	120V	24VDC 96W	ELV
 <p>Remote power supply</p> <ul style="list-style-type: none"> • TRIAC, ELV Dimming 100%-1% • Universal Input, ≤ 0.9 pf 	PS-24DC-U60R-BT	8 ¹ / ₁₆ " x 2 ¹ / ₁₆ " x 1 ¹ / ₄ "	120V-277V	24VDC 60W	ELV/TRIAC
	PS-24DC-U96R-BT	8 ¹ / ₁₆ " x 2 ¹ / ₁₆ " x 1 ¹ / ₄ "	120V-277V	24VDC 96W	ELV/TRIAC
 <p>Remote power supply</p> <ul style="list-style-type: none"> • 3 x 96W outputs (288W total) • Include 3 x 6' lead wires 	PS-24DC-U3X96R-BT	12" x 4 ⁵ / ₁₆ " x 2"	120V-277V	24VDC 3 x 96W	ELV/TRIAC/0-10V



*Not compatible with Touch Panel and Motion Sensor (CT-6A-R2)

*Not compatible with iR sensor (IR-96-24VACDC)

ACCESSORIES FOR GEMINI TAPE

Type	Model	Finish
 <p>Tape to Tape Connector Connects tape sections (10 pieces per pack)</p>	T24-BS-MM	CL Clear
 <p>Power to Tape Connector Connects power cable to tape (10 pieces per pack)</p>	T24-BS-PM	
 <p>L Connector Connects tape sections (2 pieces per pack)</p>	T24-BS-L	
 <p>Flex Y Connector Connects tape sections and power feed Includes LED-T-B (1pc)</p>	T24-BS-Y	BK Black WT White
 <p>Flex X Connector Connects tape sections and power feed Includes LED-T-B (1pc)</p>	T24-BS-X	
 <p>Low Voltage Wiring Box Neatly house connections for up to 2 wires</p>	LED-T-B	WT White

Example: **T24-BS-MM-CL**

Type	Model	Finish
 <p>Joiner Cable Extend distance between tape sections</p>	T24-BS-IC-002	BK Black WT White
	T24-BS-IC-006	
	T24-BS-IC-012	
	T24-BS-IC-036	
	T24-BS-IC-072	
 <p>Extension Cable Extends distance between tape sections and power supply (Includes LED-T-B (1 pc) & screw driver)</p>	T24-BS-EX2-072	BK Black WT White
	T24-BS-EX2-144	
	T24-BS-EX2-240	
	T24-BS-EX2-480	

Example: **T24-BS-EX2-240-WT**

Model	Finish	Input/Output	L	W	H	Description
 <p>IR-96-24VACDC-BK IR-96-24VACDC-WT</p>	Black White	24V AC/DC 96W	1 ³ / ₈ "	3/4"	3/8"	IR (Infrared) sensor switch works by turning the lights on when it becomes unobstructed. Can be surface mounted with bracket provided or double sided adhesive.

UNDER CABINET STRIP PLUG & PLAY



Accessories Included

Ideal for under cabinet lighting applications, our Strip Plug & Play fixture is easy to order and install. This low-profile luminaire is just 1/2" inch tall and 1/2" wide while delivering over 200 lumens per foot. For a clean architectural look, join the strips end-to-end seamlessly.



Input: 24VDC
Dimming: 100-10% ELV, 100-10% TRIAC
Rated Life: 50,000 hours

- Connect multiple pieces together for a seamless run
- Mount easily using clips, endcaps and joiner accessories
- Only need to purchase one length and one power supply for working system
- Construction: Aluminum with PC diffuser

	Model	Length	Wattage	Lumens	Color Temp	CRI	Finish
	LU	08 8"	3W	140	27 2700K 30 3000K	90	AL Aluminum BK Black
		20 20"	6W	360			
		40 40"	12W	700			

Example: **LU-20-30-BK**

POWER SUPPLY

Type	Model	Dimension	Input	Output
 <p>Portable power supply</p> <ul style="list-style-type: none"> • Include 6' lead wire • Integral on-off switch 	LU-2460D-P-BK	4" x 2 3/16" x 1 1/2"	120V	24VDC 60W
 <p>Portable power supply</p> <ul style="list-style-type: none"> • Include 6' lead wire 	LU-2420D-P-BK	2 3/4" x 1 5/8" x 1 1/8"	100V-240V	24VDC 24W
	LU-2420D-P-WT			
 <p>Remote power supply</p> <ul style="list-style-type: none"> • Include 6' lead wire • TRIAC, ELV Dimming • Universal Input 	LU-24DC060-UNV-RB2	8 13/16" x 2 1/16" x 2 1/4"	100V-277V	24VDC 60W
	LU-24DC096-UNV-RB2	8 13/16" x 2 1/16" x 2 1/4"	100V-277V	24VDC 96W

ACCESSORIES

Type	Model	Length	Finish	
 <p>Joiner Cable Extend Distance between sections</p>	LU-IC02 LU-IC06 LU-IC12 LU-IC36 LU-IC72	2" 6" 12" 3' 6'	Gray	
 <p>I-Connector Connect two strip lights side-by-side</p>	LU-I			
 <p>Live End Connect strip light to low voltage power supply</p>	LU-LE06 LU-LE72	6" 72"		
 <p>Multiple Terminal Block Enclosure to allow up to 6 output connections</p>	MTB-01 MTB-01-WT			Black White
 <p>End Caps Cover the end of each run</p>	LU-EC			
 <p>Fixed Base Mount strip light flush to surface</p>	LU-FB			Gray
 <p>Angled Base Mount strip light at an angle</p>	LU-AB			



LOTOS R 6" REGRESSED ADJUSTABLE RETROFIT



ALL-IN-ONE CCT SELECTABLE



Versatile and multifunctional, the Lotus R Downlights retrofit into 6-inch housings and are field adjustable up to 50 degrees in the regressed trim for quality, glare-free illumination. Offered as an All-In-One Five CCT Selectable luminaire, Lotos is ideal for recessed applications in multifamily homes, hotels, senior living and apartment buildings.

Input: 120-277V
Dimming: 100%-5% ELV, TRIAC
Rated Life: 50,000 hours

- Compatible with most standard 6" recessed cans
- 360° retractable pivot: downlight and adjustable
- Beam cutoff angle: 30°
- Edison Base (E26) adapter included
- Maximum Tilt Angle: 50°
- Construction: steel with frosted TIR lens
- IC Rated, Airtight, Wet Location Listed

	Model	Beam	Wattage	Max Lumens	Color Temp	CRI	Finish
	R6DRAK 4" Round Regressed Adjustable	A 50°	13W	1270	2700K	90	BK Black WT White
					3000K		
					9CS 3500K		
					4000K		
					5000K		

Example: **R6DRAK-A9CS-WT**





KENRIC 3.5" LED RECESSED

ALL-IN-ONE CCT SELECTABLE

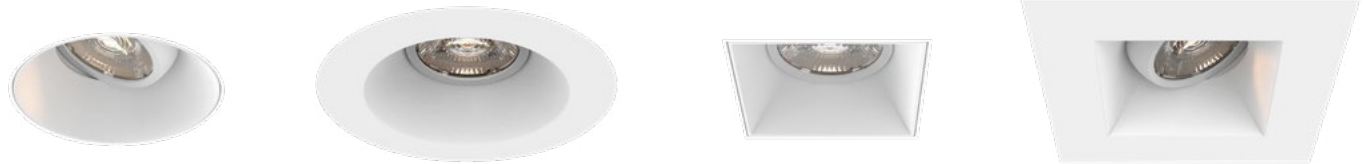

Deep regress for glare free light. 1 fixture provides downlight and adjustable functions. Housing is compatible with either round or square configuration.

Power: 15W
Input: 120-277V
Dimming: 100%-5% ELV, TRIAC and 0-10V
Rated Life: 50,000 hours

- 360° horizontal rotation, 30° vertical tilt
- Support plate included for remodel installation
- Low-profile, regressed LED for glare control
- Die-cast aluminum, white powder coat
- Driver included
- IC-rated & airtight

	Model	Beam	Max Lumens	Max CBCP	Color Temp	CRI	Finish
	R3JRAL Round Remodel Downlight/Adjustable Trimless	W 36°	1450	3430	CS 2700K 3000K 3500K 4000K 5000K	90	WT White
	R3JSAL Square Remodel Downlight/Adjustable Trimless		1420	3425			
	R3JRAT Round Remodel Downlight/Adjustable Trim		1450	3430			
	R3JSAT Square Remodel Downlight/Adjustable Trim		1420	3425			

Example: **R3JRAL-WCS-WT**

Frame-In Kit (Optional Accessory)	Model	Notes
New Construction Frame	R3JB-FRAME	Ceiling thickness: 1/2" - 1 1/2"

ION 2" LED RECESSED



ALL-IN-ONE CCT SELECTABLE



Minimum profile ION 2" Round and Square downlight with removable driver and electrical box.

Power: 9W
 Input: 120V-277V
 Dimming: 100%-10% ELV, 100%-5% TRIAC
 Rated Life: 50,000 hours

- Available as a remodel or new construction
- Installs into ceilings between 1/2" and 1 1/2" thick
- Construction: die-cast aluminum with frosted TIR lens
- IC Rated, Airtight, Wet Location Listed



	Model	Beam	Max Lumens	Max CBCP	Color Temp	CRI	Finish
	R2DRDR Round Remodel	F 30°	695	2140	9CS 2700K 3000K 3500K 4000K 5000K	90	WT White
	R2DRDN Round New Construction						
	R2DSDR Square Remodel						
	R2DSDN Square New Construction						

Example: **R2DRDR-F9CS-WT**

Frame-In Kit (Optional Accessory)	Model	Color Temp
New Construction Frame	R2DRDN-FRAME	Ceiling thickness: 1/2" - 1 1/2"



TWIST-N-LITE LUMINAIRE SYSTEM



Quick and convenient. Easy to use and easy to install, our new Twist-N-Lite system offers a variety of surface mounts and pendant luminaires in five color temperatures and three finishes. The universal mounting base accommodates our complete suite of Twist-N-Lite products. The flexible design enables you to interchange the fixtures in the field to meet your various lighting applications. This energy-efficient engineering wonder offers dimmable options for high performance and a classic, minimalistic aesthetic. Select your color temperature, Twist it in and Turn it on. Elevating multifunctional illumination to a higher standard.

Input: 120V
Dimming: 100%-10% ELV, 100%-5% TRIAC
Rated Life: 50,000 hours

- Installs over 3", 4" or combination 3/0, 4/0 electrical box
- Construction: aluminum with translucent acrylic diffuser
- Shared canopy allows for easily swapping between fixtures without adjusting the mounting hardware
- All wiring and connections are made in the junction box prior to installing the mounting base and canopy

Quick Install: Mount and power any fixture in the Twist-N-Lite family by twisting it onto the canopy



TWIST-N-LITE

ALL-IN-ONE CCT SELECTABLE



- 45° flood beam angle

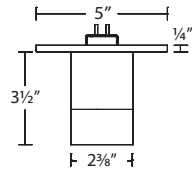

Model	Wattage	Max Lumens	Color Temp	CRI	Finish
FM-240103	12W	900	2700K	90	BK Black BN Brushed Nickel WT White
			3000K		
			3500K		
			4000K		
			5000K		

Example: **FM-240103-CS-WT**



- Dual-layer acrylic for frosted and even glow

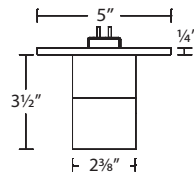

Model	Wattage	Max Lumens	Color Temp	CRI	Finish
FM-240203	9W	550	2700K	90	BK Black BN Brushed Nickel WT White
			3000K		
			3500K		
			4000K		
			5000K		

Example: **FM-240203-CS-BK**



- Dual-layer acrylic for frosted and even look
- Retract or extend the cable by pressing on the cable gripper

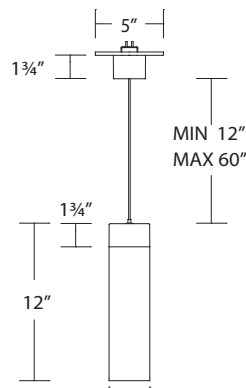

Model	Wattage	Max Lumens	Color Temp	CRI	Finish
PD-240212	13W	900	2700K	90	BK Black BN Brushed Nickel WT White
			3000K		
			3500K		
			4000K		
			5000K		

Example: **PD-240212-CS-BK**

TWIST-N-LITE

ALL-IN-ONE CCT SELECTABLE



Dual-layer acrylic for frosted and even look

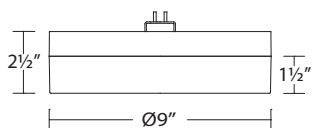

Model	Wattage	Max Lumens	Color Temp	CRI	Finish
FM-240209	22W	1500	2700K	90	BK Black BN Brushed Nickel WT White
			3000K		
			CS 3500K		
			4000K		
			5000K		

Example: **FM-240209-CS-BN**

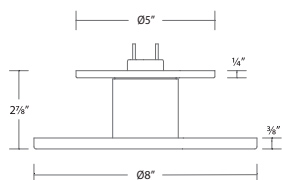

Model	Wattage	Max Lumens	Color Temp	CRI	Finish
FM-250708	10W	720	2700K	90	BK Black BN Brushed Nickel WT White
			3000K		
			CS 3500K		
			4000K		
			5000K		

Example: **FM-250708-CS-BK**

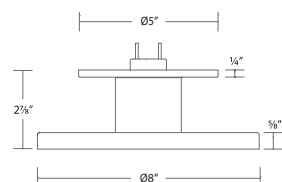

Model	Wattage	Max Lumens	Color Temp	CRI	Finish
FM-250808	14W	800	2700K	90	BK Black BN Brushed Nickel WT White
			3000K		
			CS 3500K		
			4000K		
			5000K		

Example: **FM-250808-CS-BK**

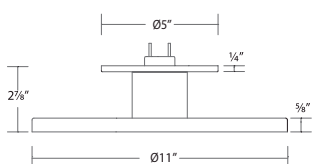

Model	Wattage	Max Lumens	Color Temp	CRI	Finish
FM-250811	19W	1200	2700K	90	BK Black BN Brushed Nickel WT White
			3000K		
			CS 3500K		
			4000K		
			5000K		

Example: **FM-250811-CS-BK**

TWIST-N-LITE



ALL-IN-ONE CCT SELECTABLE



Model	Wattage	Max Lumens	Color Temp	CRI	Finish
FM-250905	10W	660	2700K	90	BK Black BN Brushed Nickel WT White
			3000K		
			CS 3500K		
			4000K		
			5000K		

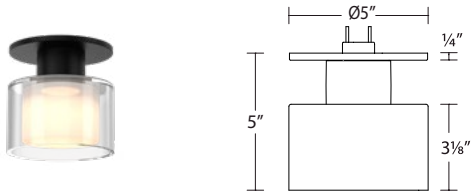

Example: **FM-250905-CS-BK**

Model	Wattage	Max Lumens	Color Temp	CRI	Finish
PD-250905	12W	850	2700K	90	BK Black BN Brushed Nickel WT White
			3000K		
			CS 3500K		
			4000K		
			5000K		

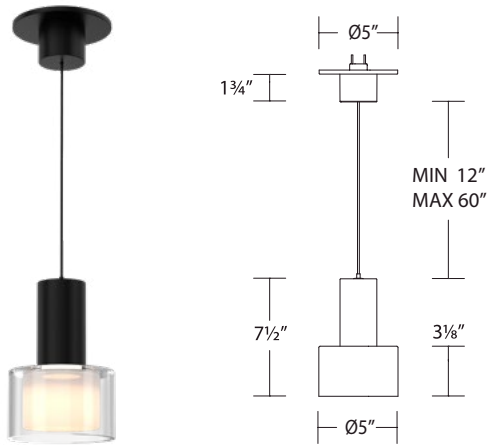

Example: **PD-250905-CS-BK**

Model	Wattage	Max Lumens	Color Temp	CRI	Finish
PD-251005	12W	880	2700K	90	BK Black BN Brushed Nickel WT White
			3000K		
			CS 3500K		
			4000K		
			5000K		

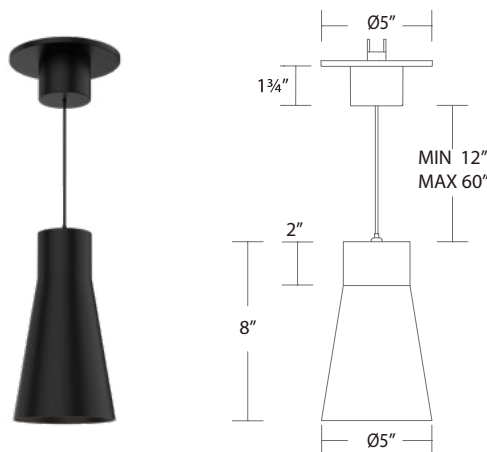

Example: **PD-251005-CS-BK**

ROUND



ALL-IN-ONE CCT SELECTABLE



This large ceiling luminaire offers an impressive size that will make a design statement while providing soft, diffused light and comforting illumination. Its robust 3,100 lumens are deployed for great rooms and larger spaces with high ceilings, or it can light up an entire walk-in closet with a single fixture. With a minimalistic design that complements a broad array of décor styles, this sleek, curvaceous luminaire integrates form and function to brighten the environment uniformly. Advanced 5-CCT All-in-One Technology provides five color temperatures from warm 2700K to cool 5000K white light.

Input: 120V
Dimming: 100%-10% ELV, 100%-5% TRIAC
Rated Life: 50,000 hours

- Sizes: 24"
- Fixture height: 1¾"
- Install into 3", 4" or a combination 3/0-4/0 electrical box
- Construction: aluminum with acrylic diffuser

	Model	Max Lumens	Wattage	Color Temp	CRI	Finish
	FM-252124	3100	45W	2700K	90	BK Black BZ Bronze WT White
				3000K		
				CS 3500K		
				4000K		
				5000K		

Example: **FM-252124-CS-BK**

DEW

ALL-IN-ONE CCT SELECTABLE



Elegant as a graceful dewdrop, this traditional domed flush mount features an appealing modern look with a soft, sweeping acrylic lens. The impressive 18" size and robust 3,000-plus lumen output are ideal for illuminating spaces with high ceilings. This ceiling fixture embraces a warm ambiance, soft illumination, and comfort like no other.

Input: 120V
Dimming: 100%-10% ELV, 100%-5% TRIAC
Rated Life: 50,000 hours

- Sizes: 18"
- Fixture height: 4¼"
- Install into 3", 4" or a combination 3/0-4/0 electrical box
- Construction: aluminum with acrylic diffuser

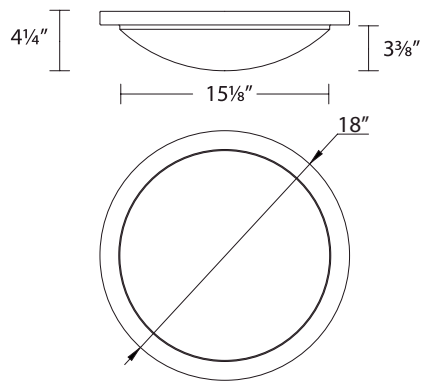

Model	Max Lumens	Wattage	Color Temp	CRI	Finish
FM-252218	3050	45W	2700K	90	BK Black BZ Bronze WT White
			3000K		
			CS 3500K		
			4000K		
			5000K		

Example: **FM-252218-CS-WT**

I CAN'T BELIEVE IT'S NOT RECESSED



ALL-IN-ONE CCT SELECTABLE



Multiple mid-powered LEDs illuminate the acrylic diffuser uniformly without socket shadows, which are common in conventional flush mounts.

Input: 120V
Dimming: 100%-10% ELV, 100%-5% TRIAC
Rated Life: 50,000 hours

- Imitates a traditional 6" line voltage recessed downlight with an -- R30 light bulb
- Install into 4" junction box or a combination 3/0-4/0 electrical box
- Construction: aluminum with translucent diffuser
- Finished screw caps included to eliminate shadows

	Model	Max Lumens	Power	Color Temp	CRI	Finish
	FM-616G2	1050	16W	2700K	90	WT White
				3000K		
				3500K		
				4000K		
				5000K		

Example: **FM-616G2-9CS-WT**

DISC LED CEILING LIGHT & RECESSED RETROFIT



FM-306-9CS-WT



FM-306MS-930JB-WT

Install over a 3" or 4" junction box or pancake box

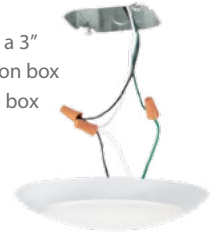

Retrofit over a 4", 5" or 6" recessed can



Multiple mid-powered LEDs uniformly illuminate the acrylic diffuser.

Input: 120V
Dimming: 100%-10% ELV, 100%-5% TRIAC
Rated Life: 50,000 hours

- FM-306MS: motion sensor keeps the fixture illuminated for 3 minutes -- before shutting off if no movement is detected
- Construction: aluminum with translucent diffuser

	Model	Max Lumens	Wattage	Color Temp	CRI	Finish	
	FM-304	650	12W	930 3000K	90	WT White	Fits over a 4" recessed can or direct wire in a 3" or 4" junction box or pancake box
	FM-306	950	15W	9CS 2700K 3000K 3500K 4000K 5000K	90	WT White	Fits over a 5" to 6" recessed can or direct wire in a 3" or 4" junction box or pancake box
	FM-306MS Infrared Motion Sensor	1100	14W	930JB 3000K	90	WT White	Direct mount on a 3" or 4" junction box or pancake box
	FM-309	1725	23W	9CSJB 2700K 3000K 3500K 4000K 5000K	90	WT White	Direct mount on a 3" or 4" junction box or pancake box

Example: **FM-306-9CS-WT**

The image shows an outdoor dining area at dusk. In the foreground, a round wooden table is set with two glasses and plates. A white, mushroom-shaped table lamp sits on the table, casting a soft glow. The table is surrounded by modern, upholstered chairs. In the background, other tables and chairs are visible, along with a large glass-walled building that is lit from within, creating a warm, ambient atmosphere. The sky is dark, and the overall scene is peaceful and inviting.

Introducing our new indoor/outdoor table lamps to complement our expanding line of lighting fixtures. Perfect for design continuity both inside and out, enhance the atmosphere throughout your home with Rechargeable Battery-operated portables. Four stylish designs are available in a variety of colorful hues, including green, white, black, and bronze. Conical-shaped shades and sleek bases ensure a clean display with a tasteful layer of light on a patio table or around a hot tub. The stunning portables are ideal for optimal ambient illumination in outdoor homes and hospitality locations.

PORTABLE TABLE LAMPS - RECHARGEABLE



Advanced CCT-select and rechargeable battery technologies allow you to choose color temperatures for any mood, from warm 2200K to 2700K to a cooler 3000 Kelvin, with an 85-plus color rendering index (CRI). Using easy onboard fingertip control, cycle through the temperatures with a quick tap, hold down to dim, or turn lamps off with firm suppression. Enjoy beautiful ambient illumination from these battery-operated lamps, which can be charged for up to 10-plus hours with the included power supply and USB-C cable. They are wet-listed for outdoor applications.

Input: USB-C
Dimming: Onboard
CRI: 85+

- Tap to switch between color temperatures (3CCT models) or hold to dim
- 7+ hours of illumination on a single charge
- Indoor/Outdoor use
- Power supply and USB-C cable included

	Model	Wattage	Max Lumens	Color Temp	Battery Life	Finish
	<p>TL-W251115</p>	2W	200	CS 2200K 2700K 3000K	10+ hours	BK Black BZ Bronze GR Green WT White
	<p>TL-W251209</p>	2W	160	CS 2200K 2700K 3000K	8+ hours	BK Black GR Green WT White
	<p>TL-W251511</p>	2W	200	CS 2200K 2700K 3000K	10+ hours	BK Black GR Green WT White
	<p>TL-W251315</p>	2W	220	27 2700K	7+ hours	BK Black WT White

Example: **TL-251511-CS-GR**

* Model TL-W251315 Crystal does not change CCT.

CAP



ALL-IN-ONE CCT SELECTABLE



This unique scrolled design features All-in-One CCT Selectable technology that ranges from warm 2700K to cool 5000K white light for various indoor and outdoor applications. Perfect for apartment doors and hotel rooms, this aluminum-constructed sconce with an acrylic diffuser can be customized with address numbers and styles to suit your project.



Input: 120V
Dimming: 100%-10% ELV, 100%-5% TRIAC
Rated Life: 50,000 hours

- Construction: aluminum with acrylic diffuser
- Finish: powder coated aluminum

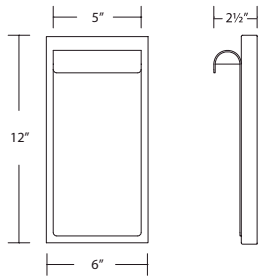

Model	Wattage	Max Lumens	Color Temp	CRI	Finish
WS-W250212	13W	365	2700K	90	BK Black GHBK Graphite on Black WTBK White on Black WT White
			3000K		
			3500K		
			4000K		
			5000K		

Example: **WS-W250212-CS-BK**

TABLET



ALL-IN-ONE CCT SELECTABLE



A minimalistic design with sleek, curvaceous appeal. Add clean lines and a beautiful ambiance to any space. Symmetrical openings allow softly diffused upward and downward illumination on surfaces below.



Input: 120V
Dimming: 100%-10% ELV, 100%-5% TRIAC
Rated Life: 50,000 hours

- Construction: aluminum with glass diffuser
- Finish: powder coated aluminum

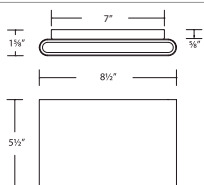

Model	Wattage	Max Lumens	Color Temp	CRI	Finish
WS-W250305	17W	810	2700K	90	BK Black BZ Bronze WT White
			3000K		
			3500K		
			4000K		
			5000K		

Example: **WS-W250305-CS-BK**



LANTERN

ALL-IN-ONE CCT SELECTABLE



A classic wall fixture that incorporates vintage-style design elements and advanced LED technology. Lantern offers an elegant way to illuminate your walkway, driveway, yard, or patio. The WAC All-in-One CCT Selectable feature allows the user to shift from warm 2700K to 5000K cool white light.

Input: 120V
Dimming: 100%-10% ELV, 100%-5% TRIAC
Rated Life: 50,000 hours

- Built-in photo sensor to control light on/off
- Construction: aluminum with TIR dual layer acrylic diffusers lens
- Finish: powder coated aluminum

	Model	Wattage	Max Lumens	Color Temp	CRI	Finish
	WS-W250110	11W	470	2700K	90	BK Black BZ Bronze WT White
				3000K		
	WS-W250114	15W	660	3500K	90	BK Black BZ Bronze WT White
				4000K		
				4700K		
				5000K		

Example: **WS-W250110-CS-BK**

MIDTOWN

ALL-IN-ONE CCT SELECTABLE



A handsome tower-styled fixture provides a soft glow and refined aesthetic that is pleasing to the eyes. Perfect for illuminating modern exterior and interior spaces, the LED luminaire offers versatility in a clean, contemporary look. This versatile sconce is constructed with die-cast aluminum for durability and quality while providing ambient and down lighting through its smooth, curvaceous acrylic diffuser. Customize the color temperature of your light from 2700K warm white to 5000K cool white.

Input: 120V
Dimming: 100%-10% ELV
Rated Life: 50,000 hours

- Sizes: 10", 15"
- Construction: die-cast aluminum with acrylic diffuser
- Finish: powder coated aluminum

	Model	Max Lumens	Wattage	Color Temp	CRI	Finish
	WS-W241310	375	12W	2700K	90	BK Black
				3000K		
	WS-W241315	625	15W	CS 3500K	90	BK Black
				4000K		
				5000K		

Example: **WS-W241310-CS-BK**



VEGA

ALL-IN-ONE CCT SELECTABLE



Add a modern vibe and powerful illumination to your porch, deck, or garage with the sleek Vega, an ADA-compliant indoor/outdoor sconce.

Input: 120V
Dimming: 100%-10% ELV
Rated Life: 50,000 hours

- Sizes: 9", 14"
- Construction: die-cast aluminum with acrylic diffuser
- Finish: powder coated aluminum

	Model	Max Lumens	Wattage	Color Temp	CRI	Finish
	WS-W190109	665	13W	CS 2700K 3000K 3500K 4000K 5000K	90	BK Black
	WS-W190114	1375	26W			

Example: **WS-W190114-CS-BK**

CHARGE 8010 & 8020



ALL-IN-ONE CCT SELECTABLE



H-8010-CS-BN



H-8020-CS-WT

Input: 120V
Dimming: 100%-10% ELV, 100%-5% TRIAC
Rated Life: 50,000 hours

- Suitable for H, J or L track
- 350° horizontal and 90° vertical aiming
- Driver concealed within fixture
- Construction: die-cast aluminum with frosted TIR lens

System	Model	Beam	Max Lumens	Max CBCP	Wattage	Color Temp	CRI	Finish
	H H Track	45°	865	1006	9W	CS	90	BK Black
	L L Track							BN Brushed Nickel
<p>Track Pack includes</p> <ul style="list-style-type: none"> • 4ft H Track • Floating Canopy • Three 8010 Charge Track Heads 	J J/J2 Track							DB Dark Bronze
	H H Track	8010						WT White
	H H Track	55°	1330	1154	15W	CS	90	BK Black
	L L Track							BN Brushed Nickel
	J J/J2 Track							DB Dark Bronze
	H H Track	8020						WT White

Example: H-8010-CS-BN

SOLO 5010, BULLET 7010, CYN 8110



ALL-IN-ONE CCT SELECTABLE



H-5010-CS-BK



H-7010-CS-WT



H-8110-CS-BK

Input: 120V
Dimming: 100%-10% ELV, 100%-5% TRIAC
Rated Life: 50,000 hours

- Suitable for H, J or L track
- 35° horizontal and 90° vertical aiming
- Driver concealed within fixture
- Construction: die-cast aluminum with frosted TIR lens

	System	Model	Beam	Max Lumens	Max CBCP	Wattage	Color Temp	CRI	Finish
	H H Track L L Track J J/J2 Track	5010	45°	870	1016	9W	CS 2700K 3000K 3500K 4000K 5000K	90	BK Black WT White
	H H Track L L Track J J/J2 Track	7010		890	1017	9W			BK Black WT White
	H H Track L L Track J J/J2 Track	8110		710	1567	10W			BK Black WT White

Example: H-5010-CS-BK

INDEX

RECESSED

OCULARC® 2.0	4
OCULARC® 3.0	5
AETHER ATOMIC.....	6
AETHER 2"	10

TRACK + MONOPOINT

OCULARC® 7011	16
OCULARC 7030	17
OCULARC 7012.....	18
OCULARC 7013.....	19
OCULARC 3020W	20
OCULARC 3020W MONOPOINT	21

INVISILED®

INVISILED® LITE+	24
INVISILED® PRO+	25
INVISILED® PRO2+.....	26
INVISILED® CHANNEL.....	28

WAC LIMITED

GEMINI.....	34
UNDER CABINET.....	36
LOTOS R.....	38
KENRIC.....	40
ION.....	42
TWIST-N-LITE.....	44
ROUND.....	48
DEW.....	49
I CAN'T BELIEVE IT'S NOT RECESSED	50
DISC.....	51
PORTABLE TABLE LAMPS	52
CAP	54
TABLET.....	54
LANTERN.....	55
MIDTOWN.....	56
VEGA.....	57
CHARGE 8010, 8020.....	58
SOLO 5010	59
BULLET 7010	59
CYN 8110.....	59

NOTES

Headquarters

Tel: 800.526.2588
Fax: 800.526.2585

44 Harbor Park Dr
Port Washington, NY 11050

Distribution and Assembly Facilities

South East

1600 Distribution Ct
Lithia Springs, GA 30122

Central

1700 South J Elmer Weaver Freeway
Suite 100
Cedar Hill, TX 75104

West

1750 S Archibald Ave
Ontario, CA 91761

Email customs@wacighting.com to learn more about our custom capabilities
in large quantities. For up to date product specifications and assistance
please visit wacighting.com or call **1-800-526-2588**

This catalog includes patented and patent-pending products or features.
We will not hesitate to enforce our intellectual property
rights through injunctive relief and seek further relief through damages
if we have reason to believe the patents are being infringed.

Copyright © 2025 by WAC Lighting. All rights reserved.
This catalog is copyrighted and WAC reserves the right to use any and all measures
available to it under the law against anyone who copies or derives from its copyrighted work.

wacighting.com