

The background of the page is a deep blue color. On the left side, there is a large, abstract graphic consisting of many thin, wavy lines that create a sense of depth and movement. These lines are arranged in a way that suggests a grid or a series of parallel paths that are slightly offset from each other, creating a 3D effect. The lines are lighter blue and become more densely packed as they move towards the center of the page. The overall effect is a dynamic and modern aesthetic.

WAC

2021

TABLE OF CONTENTS

RECESSED	4
TRACK/MONOPOINT	22
INVISILED® TAPE	28
PIXELS LED SHEET	36
OUTDOOR	40
WAC LANDSCAPE	44
WAC LIMITED	56



OCULARC

OCULARC Recessed Lighting is the standard for residential, commercial and hospitality applications. OCULARC delivers high-performance illumination from a single point source LED module and offers a clean, efficient, versatile design that works with almost any décor. 90 CRI minimum high color rendering LED and versatile dimming protocols set the standard.

OCULARC 1.0 *p. 10*

Art and accent lighting. Recessed trim, LED light engine, and configurable housing ready to install as an IC-Rated New Construction or Remodel all-in-one unit.

Nominal Aperture: 1"
Output: Up to 680lm
Color Temp: 2700K, 3000K
Installation: IC Rated Remodel, IC Rated New Construction
Flange: Trim
Dimming: ELV, TRIAC

OCULARC 2.0 *p. 11*

Powerful minimalism. Recessed trim, LED light engine, and configurable housing ready to install as an IC-Rated New Construction or Remodel all-in-one unit. Available in two lumen and wattage outputs to meet project needs.

Nominal Aperture: 2"
Output: Up to 1005lm
Color Temp: 2700K, 3000K
Installation: IC Rated Remodel, IC Rated New Construction
Flange: Trim
Dimming: ELV, TRIAC, 0-10V

OCULARC 3.0 & OCULARC 3.0 DIM-TO-WARM *p. 12-13*

The workhorse. A straight-forward recessed program available with IC Rated New Construction or IC-Rated remodel housing. Dim-to-Warm versions imitate mood transitions of incandescence.

Nominal Aperture: 3"
Output: Up to 1025lm
Color Temp: 2700K, 3000K, 3000K-1800K Dim-to-warm
Installation: IC Rated Remodel, IC Rated New Construction, Emergency Backup Option
Flange: Trim
Dimming: ELV, TRIAC, 0-10V

OCULARC 3.5 & OCULARC 3.5 DIM-TO-WARM *p. 14-19*

Architectural performance simplified. Includes trimless formats, specifiable wall washers, adjustable hot-aiming discretely above the ceiling plane, pinhole offerings and field interchangeable optics. Dim-to-Warm versions imitate mood transitions of incandescence.

Nominal Aperture: 3.5"
Output: Up to 1000lm
Color Temp: 2700K, 3000K, 3500K, 4000K, 3000K-1800K Dim-to-warm
Installation: Non-IC Rated Remodel, IC Rated Four-in-One New Construction
Flange: Trim, Trimless
Dimming: ELV, TRIAC, 0-10V

OCULARC 2" MULTIPLES *p. 6-9*

Architectural multiple source recessed lights. 1-, 2-, and 3-light low profile multiples available with trimless formats, adjustable hot-aiming mechanics discretely above the ceiling plane, pinhole offerings, and field interchangeable optics. Individually dimming magnet mounted light engines provide superior versatility.

Nominal Aperture: 2"
Output: Up to 1280lm per head
Color Temp: 2700K, 3000K, 3500K, 4000K
Installation: Non-IC, IC Rated New Construction
Flange: Trim, Trimless
Dimming: ELV, TRIAC, 0-10V

OCULARC 2" MULTIPLE SPOTS
ARCHITECTURAL MULTIPLE SOURCE RECESSED LIGHTS

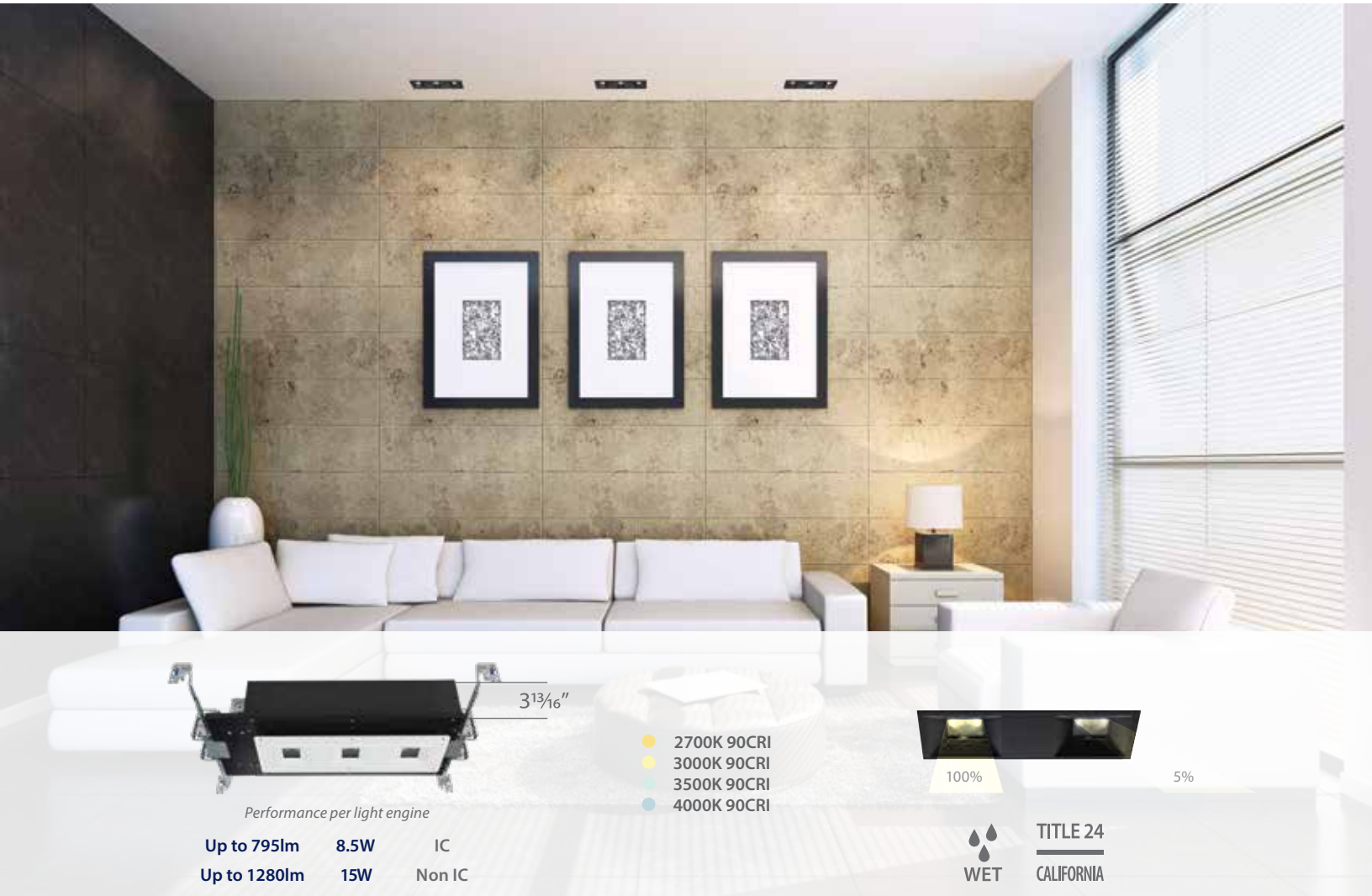

Unobtrusive, low profile design provides superior color rendering regardless of color temperature.
Rare earth magnetic light engine mounting makes installation and maintenance easy.

MINIMAL FOOTPRINT

Small housing fits into tight plenum spaces

DESIGN FLEXIBILITY

Choice of IC or Non IC and power options

QUALITY ILLUMINATION

90 CRI for excellent color rendering across multiple CCT options

VERSATILITY

Individual light engine control standard/Universal dimming protocols

FEATURE RICH

Wet Location Listed standard/Title 24 Compliant. Magnetic light engine for ease of serviceability

OCULARC 2" MULTIPLE SPOTS
ARCHITECTURAL MULTIPLE SOURCE RECESSED LIGHTS



HOUSING

Universal Housing 120V-277V
Airtight, IC Rated and Non IC option
Universal housing can be used with Trim or Trimless

Light engines can be independently operated



ADJUSTABLE LIGHT ENGINE

Revolutionary design ensures center beam alignment is maintained throughout 0°-40° tilt and 360° horizontal rotation

Rare earth magnetic light engine mounting makes both installation and maintenance easy

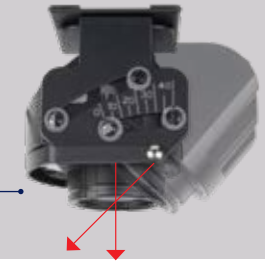

ACCESSORIES

Optional field changeable optic film accessories available

Accommodates one lens or glare control accessory
Accessory holder sold separately

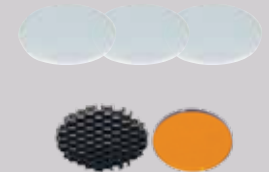

TRIMS

Powder coated die-cast aluminum construction
Wet Location Listed with optional lens

Trim



BEVEL

General illumination with high lumen output

Trimless

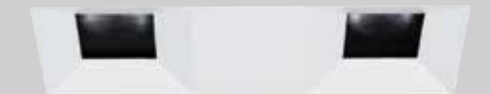

PINHOLE

Small aperture with superior glare control

Trimless



OCULARC 2" MULTIPLE SPOTS

ARCHITECTURAL MULTIPLE SOURCE RECESSED LIGHTS



Input: 120V-277V
Rated Life: 50,000 hours
CRI: 90
Dimming: 100%-5% ELV, TRIAC
 100%-5% 0-10V

- Vertical adjustable aiming 40°, horizontal adjustable aiming 360°
- Refined 2" aperture and shallow <4" housing height
- Bevel and pinhole trim options
- Trim and Trimless (shared housing)
- Accommodates one lens accessory or honeycomb louver
- Rare earth magnetic light engine mounting

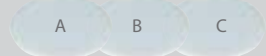

Accessory Films included in Optic Film Package

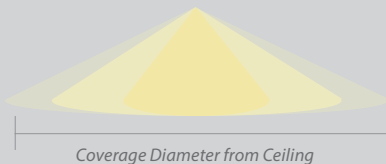

ACCESSORY OPTIC FILMS sold separately

MT-2-FILM

Optic Film Package: includes 3 films (A, B, C)
LENS-11-HLD Required (sold separately)

Primary Optic	Accessory Film	Resulting Beam
S (16°)	A	25°
S (16°)	B	45°
S (16°)	C	55°
N (30°)	A	35°
N (30°)	B	55°
N (30°)	C	65°
F (50°)	A	52°
F (50°)	B	70°
F (50°)	C	80°

Coverage Diameter From 8' Ceiling in feet

Primary Optic	No Film	+ Film A	+ Film B	+ Film C
Spot	2'	3.5'	6.5'	8.5'
Narrow	4.5'	5'	8.5'	10'
Flood	7.5'	8'	11'	13.5'

Coverage Diameter From 10' Ceiling in feet

Primary Optic	No Film	+ Film A	+ Film B	+ Film C
Spot	3'	4.5'	8.5'	10.5'
Narrow	5.5'	6.5'	10.5'	12.5'
Flood	9.5'	10'	14'	17'

1 LIGHT

Model	Power	Beam	Bevel Trim		Pinhole Trim		Color Temp	
			Max Lumens	Max CBCP	Max Lumens	Max CBCP		
MT-2109 New Construction IC Rated, Airtight	8.5W	S 16°	700	6075	680	5915	927 2700K	
			N 30°	650	1825	605		1830
			F 50°	795	1095	760		1070
MT-2115 New Construction Non-IC, Airtight	15W	S 16°	1085	9660	1070	9510	935 3500K	
			N 30°	1055	2840	920		2825
			F 50°	1280	1765	1180		1665

Example: **MT-2109-S935**

Model	Finish
MT-21DL 1 Light Trimless Bevel	BK Black WT White
MT-21PT 1 Light Trim Pinhole	BK Black WT White trim with black interior
MT-21PL 1 Light Trimless Pinhole	BK Black WT White trim with black interior

Example: **MT-21DL-WT**

OCULARC 2" MULTIPLE SPOTS

ARCHITECTURAL MULTIPLE SOURCE RECESSED LIGHTS



2 LIGHTS

Model	Power	Beam	Bevel Trim		Pinhole Trim		Color Temp	
			Max Lumens	Max CBCP	Max Lumens	Max CBCP		
MT-2209 New Construction IC Rated, Airtight	17W	S 16°	700 x2	6075 x2	680 x2	5915 x2	927 2700K	
			N 30°	650 x2	1825 x2	605 x2		1830 x2
			F 50°	795 x2	1095 x2	760 x2		1070 x2
MT-2215 New Construction Non-IC, Airtight	30W	S 16°	1085 x2	9660 x2	1070 x2	9510 x2	935 3500K	
			N 30°	1055 x2	2840 x2	920 x2		2825 x2
			F 50°	1280 x2	1765 x2	1180 x2		1665 x2

Example: **MT-2209-S935**

Model	Finish
MT-22DL 2 Light Trimless Bevel	BK Black WT White
MT-22PT 2 Light Trim Pinhole	BK Black WT White trim with black interior
MT-22PL 2 Light Trimless Pinhole	BK Black WT White trim with black interior

Example: **MT-22DL-WT**

3 LIGHTS

Model	Power	Beam	Bevel Trim		Pinhole Trim		Color Temp	
			Max Lumens	Max CBCP	Max Lumens	Max CBCP		
MT-2309 New Construction IC Rated, Airtight	25.5W	S 16°	700 x3	6075 x3	680 x3	5915 x3	927 2700K	
			N 30°	650 x3	1825 x3	605 x3		1830 x3
			F 50°	795 x3	1095 x3	760 x3		1070 x3
MT-2315 New Construction Non-IC, Airtight	45W	S 16°	1085 x3	9660 x3	1070 x3	9510 x3	935 3500K	
			N 30°	1055 x3	2840 x3	920 x3		2825 x3
			F 50°	1280 x3	1765 x3	1180 x3		1665 x3

Example: **MT-2315-S935**

Model	Finish
MT-23DL 3 Light Trimless Bevel	BK Black WT White
MT-23PT 3 Light Trim Pinhole	BK Black WT White trim with black interior
MT-23PL 3 Light Trimless Pinhole	BK Black WT White trim with black interior

Example: **MT-23PT-BK**

ACCESSORY HOLDER sold separately

LENS-11-HLD Required for use with any lens or accessory

GLARE CONTROL ACCESSORIES sold separately

LENS-11-HCL Honeycomb Louver

LENS ACCESSORIES sold separately

LENS-11	Color	Effect
AMB	Amber	SPR Spread
RED	Red	BEL Beam Elongating
FR	Frosted	

OCULARC 1.0 LED RECESSED
ART AND ACCENT LIGHTING

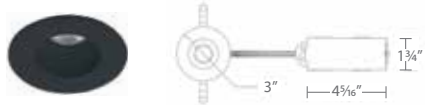
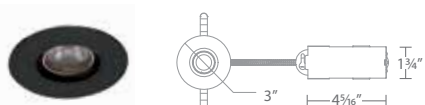
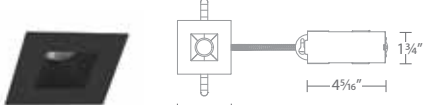
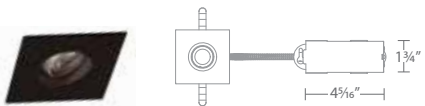

- Power:** 7.5W
Comparable to: 50W MR16
Input: 120V
Rated Life: 50,000 hours
CRI: 90
- Sold as new construction, may be reconfigured in the field for remodel use
 - Cutout: 2½"
 - Single LED module for high-performance illumination without hot spots
 - Ceiling thickness: ½"-1"
 - ELV or TRIAC dimming compatible

Model	Beam	Max Lumens	Max CBCP	Color Temp	Finish
 R1BRD-08 Round Open Reflector Wet Location Listed 30° visual cutoff	N 25° F 45°	670	2397	927 2700K 930 3000K	BK Black BN Brushed Nickel HZWT Haze/White WT White
 R1BRA-08 Round 0-20° Adjustable 14° visual cutoff	N 25° F 45°	680	2405	927 2700K 930 3000K	BK Black BN Brushed Nickel WT White
 R1BSD-08 Square Open Reflector Wet Location Listed 30° visual cutoff	N 25° F 45°	665	2390	927 2700K 930 3000K	BK Black BN Brushed Nickel HZWT Haze/White WT White
 R1BSA-08 Square 0-20° Adjustable 14° visual cutoff	N 25° F 45°	680	2405	927 2700K 930 3000K	BK Black BN Brushed Nickel WT White

Example: **R1BRD-08-N930-WT**

INTEGRAL HOUSING AND TRIM: BOTH NEW CONSTRUCTION & REMODEL

NEW CONSTRUCTION CONFIGURATION
IC Rated, Airtight

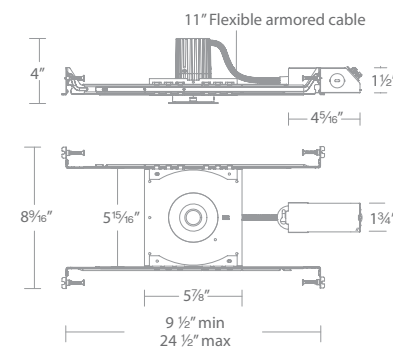

REMODEL CONFIGURATION
IC Rated, Airtight

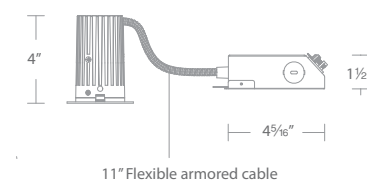

All-in-one unit, ready to install right out of the box



OCULARC 2.0 LED RECESSED
POWERFUL MINIMALISM

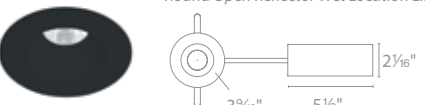
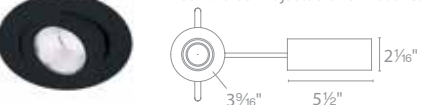
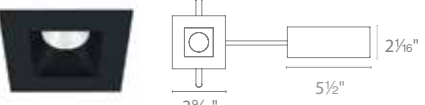
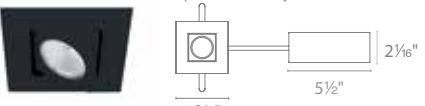

- Power:** 9W/11W
Comparable to: 50W MR16
Input: 120V
Rated Life: 50,000 hours
CRI: 90
- Sold as new construction. May be configured in the field for remodel use
 - Cutout: 3½"
 - Single LED module for high-performance illumination without hot spots
 - Ceiling thickness: ½"-1"
 - ELV or TRIAC or 0-10V dimming compatible

Model	Max Lumens	Max CBCP	Beam	Color Temp	Finish
 Round Open Reflector Wet Location Listed 35° visual cutoff	680 940	2490 2957	N 25° F 45°	927 2700K 930 3000K	BK Black BN Brushed Nickel HZWT Haze/White WT White
 Round 0-35° Adjustable 45° visual cutoff	685 1005	3245 4666	S 15° N 25° F 45°	927 2700K 930 3000K	BK Black BN Brushed Nickel WT White
 Square Open Reflector Wet Location Listed 35° visual cutoff	700 955	2462 2749	N 25° F 45°	927 2700K 930 3000K	BK Black BN Brushed Nickel HZWT Haze/White WT White
 Square 0-35° Adjustable 45° visual cutoff	685 1005	3245 4666	S 15° N 25° F 45°	927 2700K 930 3000K	BK Black BN Brushed Nickel WT White

Example: **R2BRD-11-N930-WT**

INTEGRAL HOUSING AND TRIM: BOTH NEW CONSTRUCTION & REMODEL

NEW CONSTRUCTION CONFIGURATION
IC Rated, Airtight

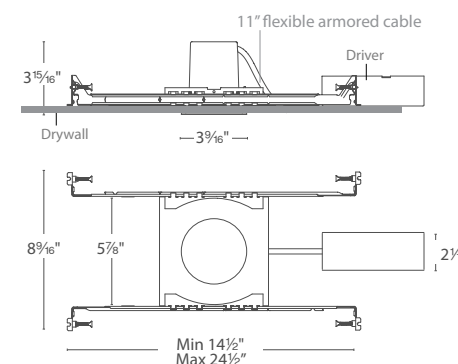



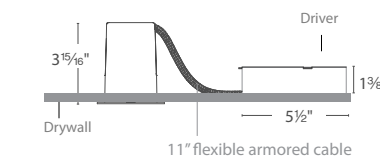





REMODEL CONFIGURATION
IC Rated, Airtight

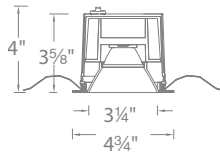
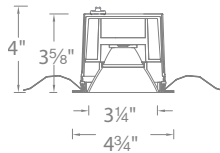

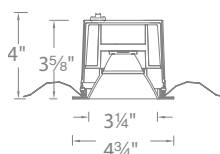
All-in-one unit, ready to install right out of the box

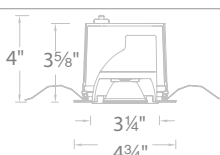
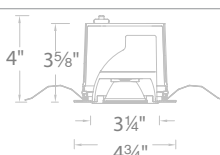

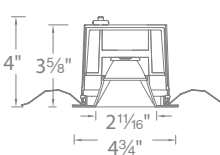
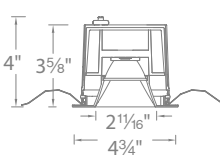

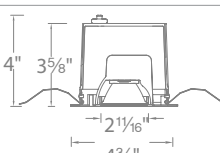
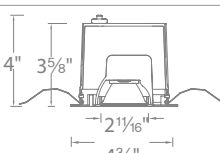

Trims (Order Housing Separately)	Model	Beam	Max Lumens	Max CBCP	Color Temp	Finish
  <p>R3BRD Round Open Reflector Wet Location Listed 40° visual cutoff</p>	S Spot	N Narrow	970	5132	927 2700K	BK Black
					930 3000K	BN Brushed Nickel
	F Flood				WD 3000K-1800K	WT White
  <p>R3BRDP Polycarbonate Trim Face* Open Reflector Wet Location Listed</p>	S Spot	N Narrow	1025	5144	927 2700K	WT White
					930 3000K	
  <p>R3BRA Round 0-35° Adjustable 48° visual cutoff</p>	S Spot	N Narrow	985	4712	927 2700K	BK Black
					930 3000K	BN Brushed Nickel
	F Flood				WD 3000K-1800K	WT White
  <p>R3BSD Square Open Reflector Wet Location Listed 35° visual cutoff</p>	S Spot	N Narrow	930	4823	927 2700K	BK Black
					930 3000K	BN Brushed Nickel
	F Flood				WD 3000K-1800K	WT White
  <p>R3BSA Square 0-35° Adjustable 48° visual cutoff</p>	S Spot	N Narrow	985	4712	927 2700K	BK Black
					930 3000K	BN Brushed Nickel
	F Flood				WD 3000K-1800K	WT White

Example: **R3BRD-S927-WT**

Power: 11W
 Comparable to: 75W MR16
 Input: 120V or 277V
 Rated Life: 50,000 hours
 CRI: 90, 95

- IC Rated, Airtight in Remodel and New Construction
- Shallow housing under 4" depth
- Cutout: 4 1/4"
- Single LED module for high-performance illumination without hot spots
- Ceiling thickness: 1/2"-1"
- Dimming: 100%-5% TRIAC, ELV, 100%-1% 0-10V

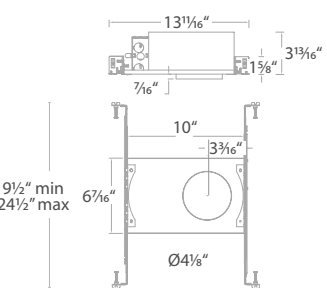

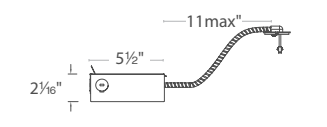
Housings (Required) - Order Separately From Trims	Model	Input	Dimming	Notes
 	R3BNICA-10 IC Rated, Airtight	120V	100%-5% TRIAC, ELV, 0-10V	Less than 4" plenum depth Allows adjustment in any direction when used with adjustable trims
	R3BNICA-10U IC Rated, Airtight	120V-277V	120V 100%-5% TRIAC, ELV, 0-10V 277V 100%-1% 0-10V	Ceiling thickness: 1/2"-1"
	R3BNICA-10U-EM Emergency Backup IC Rated, Airtight	120V-277V	120V 100%-5% TRIAC, ELV, 0-10V 277V 100%-1% 0-10V	Provides 90 minutes of emergency illumination
 	R3BBRT-10 IC Rated	120V	100%-5% TRIAC, ELV, 0-10V	4 1/4" plenum depth Allows adjustment in any direction when used with adjustable trims Ceiling thickness: 1/2"-1"



PERFORMANCE SIMPLIFIED

OCULARC 3.5—performance features in a simple but versatile package for residential and commercial applications alike.

PERFORMANCE

Lumens: Up to 1,000
CRI: 90
CCT: 2700K, 3000K, 3500K, 4000K
Rated Life: 50,000 hours

SIMPLE

Cost effective, as with all of our OCULARC LED downlights

NEW CONSTRUCTION

- Downlight, Adjustable, Pinhole, Wall Wash
- Spot, Narrow Flood, or Flood with all optics included
- Trim or Trimless with die-cast Spackle Frame included

PAINLESS ORDERING

- All Airtight
- All Wet Location Listed
- Universal Voltage: 120-277V
- Universal Dimming: TRIAC, ELV, 0-10V

REMODEL

- Downlight, Adjustable, Pinhole, Wall Wash
- Spot, Narrow Flood, or Flood with all optics included
- Dedicated Trim or Trimless remodel housing

FOUR-IN-ONE NEW CONSTRUCTION HOUSING

Downlight, 0°-30° Adjustable, Pinhole and Wall Wash





3000K



1800K

The LED downlight that warms as you dim. Imitates incandescent light with our intuitive Dim-to-warm technology. ELV, TRIAC, and 0-10V dimming protocols available standard for integration with virtually any control system.

FOUR-IN-ONE NEW CONSTRUCTION HOUSING

Downlight, 0°-30° Adjustable, Pinhole and Wall Wash



HOUSING

Universal Housing 120V-277V
Airtight, IC Rated and Non IC option
Round and Square option

Field adjustable collar adapts to 1/2"-1" ceiling thicknesses

Die-cast trimless spackle frame included



SPOT & FLOOD OPTICS

Narrow beam TIR Lens pre installed with every housing
Interchangeable Flood optic supplied



ADJUSTABLE LIGHT ENGINE

Sliding 0°-30° tilt maximizes light projection through aperture
365° horizontal rotation with dim-to-warm LED technology



Indexed hot-aiming

FOUR-IN-ONE NEW CONSTRUCTION HOUSING

Downlight, 0°-30° Adjustable, Pinhole and Wall Wash

TRIMS

Powder coated die-cast aluminum construction
Wet Location Listed with optional lens



DOWNLIGHT & ADJUSTABLE

0°-30° adjustment above the ceiling

ADJUSTABLE PINHOLE

0°-30° adjustment above the ceiling

WALL WASH

Adjusts to 15° position



ROUND
NEW CONSTRUCTION HOUSING

Downlight, 0°-30° Adjustable, Adjustable Pinhole and Wall Wash
Universal Voltage and Universal Dimming
IC and Non IC, Airtight, and Wet Location Listed

- Input:** 120V - 277V
Rated Life: 50,000 hours
CRI: 90, 95
- Die-cast trimless spackle frame included for use with flangeless trims
 - Vertical Adjustment 0-30°, Horizontal Adjustment 365°
 - Dimming: 100%-1% ELV, TRIAC
100%-5% 0-10V

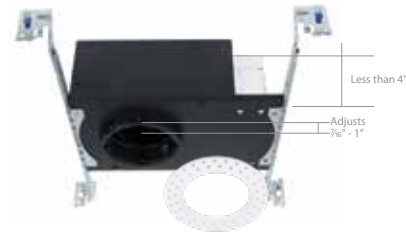

Housings (Required) - Order Separately From Trims

Model	Power	Color Temp
R3CRN-11 Round IC-Rated Airtight	13W	927 2700K 930 3000K 935 3500K 940 4000K
R3CRN-13 Round IC-Rated Airtight	13W	WD 1800K-3000K
R3CRN-16 Round Non IC Airtight	16W	WD 1800K-3000K

Example: **R3CRN-13-WD**

ROUND
REMODEL HOUSING

Downlight, 0°-30° Adjustable, Adjustable Pinhole and Wall Wash
Universal Voltage and Universal Dimming
Non -IC, Airtight, and Wet Location Listed

- Input:** 120V - 277V
Rated Life: 50,000 hours
CRI: 90, 95
- Die-cast trimless spackle frame included for use with flangeless trims
 - Vertical Adjustment 0-30°, Horizontal Adjustment 365°
 - Dimming: 100%-1% ELV, TRIAC
100%-5% 0-10V



Housings (Required) - Order Separately From Trims

Model	Power	Color Temp
R3CRR-11 Round Trim	13W	927 2700K 930 3000K 935 3500K 940 4000K
R3CRR-16 Round Trim	16W	WD 1800K-3000K
R3CRR-11 Round Trimless	13W	927 2700K 930 3000K 935 3500K 940 4000K
R3CRR-16 Round Trimless	16W	WD 1800K-3000K

Example: **R3CRR-16-WD**

OCULARC 3.5 OCULARC 3.5 Dim-To-Warm
Trims (Required)
Order Housing Separately

Model	Finish	Power	Beam	Max Lumens	Max CBCP	Max Lumens	Max CBCP	
R3CRDT Round Downlight & Adjustable Wet Location Listed	BK HZWT WT Black Haze/White White	13W	16° 36° 51°	980 965 930	5740 1684 966	34° 60°	860 750	2110 665
		16W		N/A			34° 60°	1020 890
R3CRPT Round Adjustable Pinhole Wet Location Listed	BK WT Black White	13W	16° 32° 44°	825 720 665	5762 1640 948	32° 54°	760 600	2115 660
		16W		N/A			32° 54°	900 710
R3CRWT Round Wall Wash Wet Location Listed	BK HZWT WT Black Haze/White White	13W	Asym	680	N/A	Asym	630	N/A
		16W		N/A			Asym	745
R3CRDL Round Downlight & Adjustable Wet Location Listed	BK HZ WT Black Haze White	13W	16° 36° 51°	980 965 930	5740 1684 966	34° 60°	860 750	2100 665
		16W		N/A			34° 60°	1020 890
R3CRPL Round Adjustable Pinhole Wet Location Listed	BK WT Black White	13W	16° 32° 44°	825 720 665	5762 1640 948	32° 54°	760 600	2115 660
		16W		N/A			32° 54°	900 710
R3CRWL Round Wall Wash Wet Location Listed	BK HZ WT Black Haze White	13W	Asym	680	N/A	Asym	630	N/A
		16W		N/A			Asym	745

Example: **R3CRWL-HZ**

GLARE CONTROL ACCESSORIES sold separately

LENS-16	HCL	Honeycomb Louver
----------------	------------	------------------

Not compatible with Dim-To-Warm

LENS ACCESSORIES sold separately

LENS-16	AMB	Amber	SPR	Spread	
	RED	Red		BEL	Beam Elongating
	FR	Frosted			

Not compatible with Dim-To-Warm

SQUARE NEW CONSTRUCTION HOUSING

Downlight, 0°-30° Adjustable, Adjustable Pinhole and Wall Wash
Universal Voltage and Universal Dimming
IC and Non IC, Airtight, and Wet Location Listed

- Input:** 120V - 277V
Rated Life: 50,000 hours
CRI: 90, 95
- Die-cast trimless spackle frame included for use with flangeless trims
 - Vertical Adjustment 0-30°, Horizontal Adjustment 365°
 - Dimming: 100%-1% ELV, TRIAC
100%-5% 0-10V

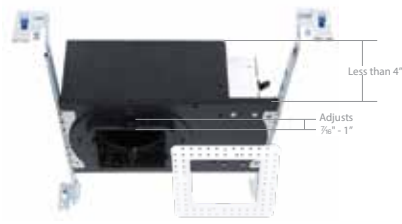

Housings (Required) - Order Separately From Trims

Model	Power	Color Temp
R3CSN-11 Square IC-Rated Airtight	13W	927 2700K 930 3000K 935 3500K 940 4000K
R3CSN-13 Square IC-Rated Airtight	13W	WD 1800K-3000K
R3CSN-16 Square Non IC Airtight	16W	WD 1800K-3000K

Example: **R3CSN-13-WD**

SQUARE REMODEL HOUSING

Downlight, 0°-30° Adjustable, Adjustable Pinhole and Wall Wash
Universal Voltage and Universal Dimming
Non-IC, Airtight, and Wet Location Listed

- Input:** 120V - 277V
Rated Life: 50,000 hours
CRI: 90, 95
- Die-cast trimless spackle frame included for use with flangeless trims
 - Vertical Adjustment 0-30°, Horizontal Adjustment 365°
 - Dimming: 100%-1% ELV, TRIAC
100%-5% 0-10V



Housings (Required) - Order Separately From Trims

Model	Power	Color Temp
R3CSR-11 Square Trim	13W	927 2700K 930 3000K 935 3500K 940 4000K
R3CSR-16 Square Trim	16W	WD 1800K-3000K
R3CSRL-11 Square Trimless	13W	927 2700K 930 3000K 935 3500K 940 4000K
R3CSRL-16 Square Trimless	16W	WD 1800K-3000K

Example: **R3CSR-11-930**

Trims (Required) Order Housing Separately

Model	Finish	Power	Beam	Max Lumens	Max CBCP	OCULARC 3.5	OCULARC 3.5 Dim-To-Warm	
R3CSDT Square Downlight & Adjustable Wet Location Listed	BK HZWT WT Black Haze/White White	13W	16° 36° 51°	1000 990 915	5799 1671 953	34° 60°	865 790	2165 665
		16W		N/A			34° 60°	1025 930
R3CSPT Square Adjustable Pinhole Wet Location Listed	BK WT Black White	13W	16° 34° 44°	865 810 740	5757 1580 911	32° 54°	795 600	2165 625
		16W		N/A			32° 54°	940 710
R3CSWT Square Wall Wash Wet Location Listed	BK HZWT WT Black Haze/White White	13W	Asym	705	N/A	Asym	610	N/A
		16W		N/A			Asym	720

Trimless

R3CSDL Square Downlight & Adjustable Wet Location Listed	BK HZ WT Black Haze White	13W	16° 36° 51°	1000 990 915	5799 1671 953	34° 60°	865 790	2165 665
		16W		N/A			34° 60°	1025 930
R3CSPL Square Adjustable Pinhole Wet Location Listed	BK WT Black White	13W	16° 34° 44°	865 810 740	5757 1580 911	32° 54°	795 600	2165 625
		16W		N/A			32° 54°	940 710
R3CSWL Square Wall Wash Wet Location Listed	BK HZ WT Black Haze White	13W	Asym	705	N/A	Asym	610	N/A
		16W		N/A			Asym	725

Example: **R3CSWL-BK**

GLARE CONTROL ACCESSORIES sold separately

LENS-16	HCL	Honeycomb Louver
----------------	------------	------------------

Not compatible with Dim-To-Warm

LENS ACCESSORIES sold separately

LENS-16	AMB	Amber	SPR	Spread
	RED	Red		BEL
	FR	Frosted		

Not compatible with Dim-To-Warm

SILO COLLECTION

Sleek, discreet design combined with high-performance LED technology. Silo features a continuously adjustable beam angle and an intuitive, removable front cap for optional lens or glare control accessories. Silo is the perfect choice for any application.

Features:

- Up to 2520 delivered lumens
- Continuous variable beam adjustment
- Available in multiple designer finish options
- Multiple CCT options
- Accommodates 1 lens and 1 glare control accessory

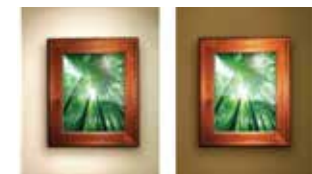

without Framing Projector with Framing Projector



Optional Framing Projector Accessory



Monopoint available

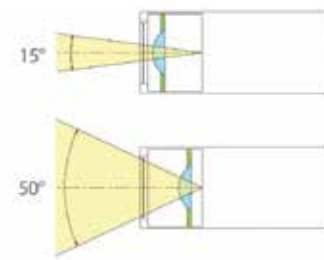

OCULARC COLLECTION

With high-output LED technology, integral driver and three beam angle options included, OCULARC is the standard for residential, commercial, and hospitality applications.

Features:

- Up to 2025 delivered lumens
- Interchangeable beam options included
- Available in multiple designer finish options
- Dim-To-Warm technology
- Option available with lens or glare control accessories

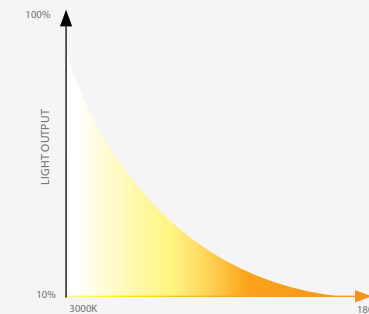

Available in Dim-To-Warm Technology

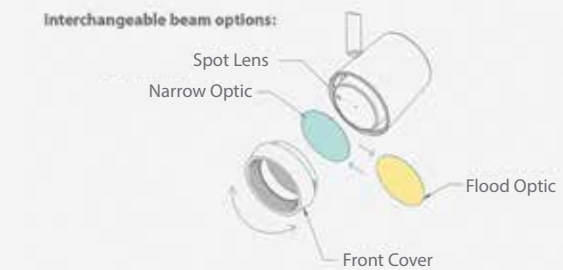

EXTERMINATOR II COLLECTION

Superior light output in a small, unobtrusive design. Exterminator II was specifically designed for use in upscale residential and commercial environments, and features horizontal rotation, vertical aiming, and a removable front cap for easy, in-the-field changing of lenses. A variety of optional lens accessories are available to provide the right amount of light for virtually any application.

Features:

- Up to 4237 delivered lumens
- Accommodates one lens accessory and one glare control accessory
- Reflectors can be purchased separately for alternative beam angles
- 365° horizontal rotation and 180° vertical aiming



CHARGE COLLECTION

Superior light output in a small, unobtrusive design. Developed for residential spaces and lower mounted commercial applications.

Features:

- Up to 1280 delivered lumens
- Available in white or black finishes
- Also available in 3-light 4' track kit



Track luminaires are offered in H, L, J or J2 adapters. Specify as needed.

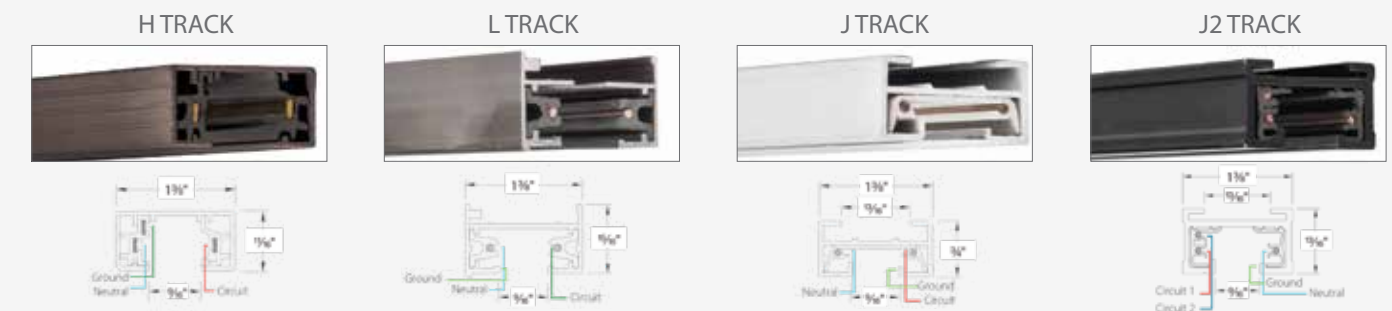



Power: 28W
 Input: 120V, 277V
 Dimming: 100%-5% (ELV & TRIAC)
 Rated Life: 50,000 hours
 Listing: ETL & cETL, Title 24 JA8 2016 Compliant

Museum-quality LED luminaire with adjustable beam angle

- Continuously adjustable beam angles from 46° by 70° to 100° by 120° (NEMA 3x4 to NEMA 5x6)
- Rotate fixture head for vertical distribution
- 365° horizontal aiming and 90° vertical aiming
- Accommodates one lens and one glare control accessory
- Patents Pending

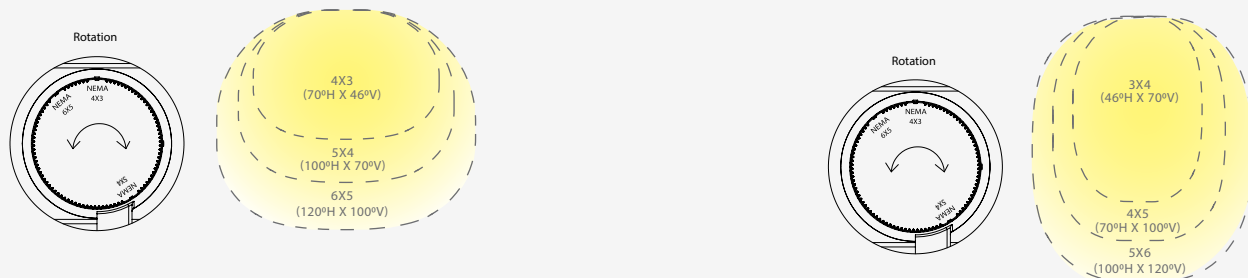

Architectural beam distributions from 3x4 to 4x5 to 5x6 proportions and everything in-between. Always a uniform wide beam wash of light.

Accommodates one lens accessory and one glare control accessory

GLARE CONTROL ACCESSORIES

	5028-SHR-BK 5028-SHR-WT 5028-SHR-PT
	5028-HSHR-BK 5028-HSHR-WT 5028-HSHR-PT
	5028-VSHR-BK 5028-VSHR-WT 5028-VSHR-PT

LENS ACCESSORIES

Amber	4LENS-3X5-AMB	Frosted	4LENS-3X5-FR
Blue	4LENS-3X5-BLU	Spread	4LENS-3X5-SPR
Green	4LENS-3X5-GRN	Beam Elongating	4LENS-3X5-BEL
Red	4LENS-3X5-RED		

WTK/WHK



Construction: Die-cast Aluminum
 Delivered Lumens: Up to 2070
 Standards: ETL & cETL Dry Location Listed

System	Model	Color Temp	CRI	Max Lumens	Max CBCP	Finish
WTK WHK	W Track 120V W Track 277V	5028W	927 2700K 90	1925	745	BK Black PT Platinum WT White
			930 3000K 90	2000	775	
			935 3500K 90	2025	785	
			940 4000K 90	2070	800	

Example: **WTK-5028W-930-BK**

HLJ



Construction: Die-cast Aluminum
 Delivered Lumens: Up to 2070
 Standards: ETL & cETL Dry Location Listed

System	Model	Color Temp	CRI	Max Lumens	Max CBCP	Finish
H L J	H L J/J2	5028W	927 2700K 90	1925	745	BK Black WT White
			930 3000K 90	2000	775	
			935 3500K 90	2025	785	
			940 4000K 90	2070	800	

Example: **H-5028W-930-WT**

MONOPOINT



Construction: Die-cast Aluminum
 Delivered Lumens: Up to 2070
 Standards: ETL & cETL Damp Location Listed

Model	Color Temp	CRI	Max Lumens	Max CBCP	Finish
5028W	927 2700K 90	1925	745	BK Black WT White	
	930 3000K 90	2000	775		
	935 3500K 90	2025	785		
	940 4000K 90	2070	800		

Example: **MO-5028W-930-BK**

SILO LED PENDANT



PD-2020-930-WT/GL

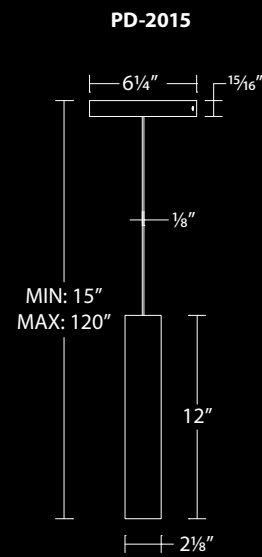

PD-2015

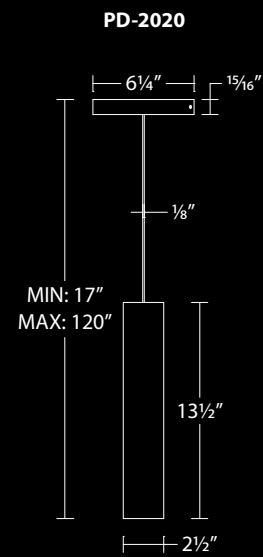

PD-2020

Thin powered suspension cable matches pendant body finish
Retractable accenting collar extends up to 3/8" for two toned appearance.

SILO LED PENDANT



Dimming: ELV, 0-10V (Canopy mount), ELV (Track)
Input: 120-277V (Canopy mount), 120V (Track)
Rated Life: 50,000 hours

- Available as canopy mount and for H/L/J Track
- Single screw canopy for easy junction box installation with canopy mount
- Universal voltage driver concealed within canopy
- All canopy mounts and H/L/J-PD2015 are Title 24 Compliant
- Accenting collar included, see ordering table for finishes



PD-2020-930-WT/BK

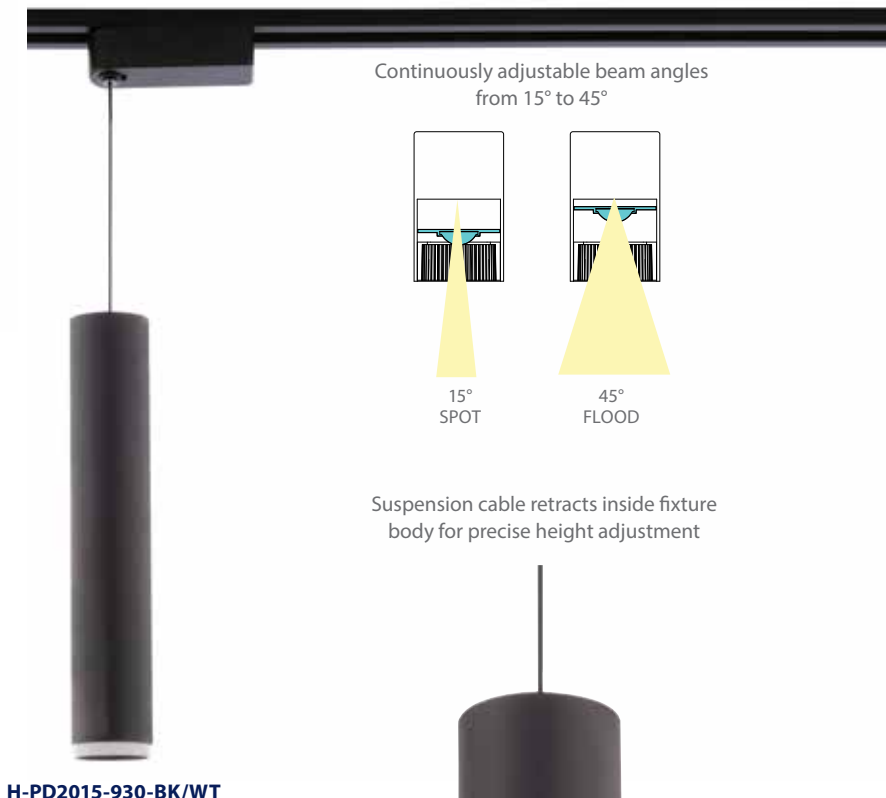

PD-2020-930-BK/GL

H-PD2015-930-BK/WT

Model	Power	Beam	Max Lumens	CBCP	Color Temp	CRI	Finish	Body/Finish	
PD-2015	15W	15°	415	3192	927 2700K	90	BK/BK	Black/Black	
		45°	755	1371				BK/GL	Black/Gold
								BK/WT	Black/White
PD-2020	20W	15°	820	6561	935 3500K	90	WT/BK	White/Black	
		45°	1170	1752				WT/GL	White/Gold
								WT/WT	White/White

Example: PD-2015-930-BK/WT

System	Model	Power	Beam	Lumens	CBCP	Color Temp	CRI	Finish	Body/Finish
H L J	H Track	PD2015	15°	420	3214	927 2700K	90	BK/BK	Black/Black
			45°	895	1631				BK/GL
	L Track	PD2015	15°	760	5944	935 3500K	90	BK/WT	Black/White
			45°	1125	1722				WT/BK
	J/J2 Track	PD2020	15°	760	5944	940 4000K	90	WT/BK	White/Black
			45°	1125	1722				WT/GL
							WT/WT	White/White	

Example: H-PD2020-930-BK/BK

INVISILED® CCT

COLOR TEMPERATURE ADJUSTABLE TAPE



.4" Actual size shown



Input: 24VDC
 Dimming: ELV, 0-10V
 Lumens: Up to 600 lm/ft
 Rated Life: 50,000 hours
 CRI: 95

- May be cut and easily reconnected every 4 inches
- Select and choose desirable CCT with matching CCT selectable power supply
- UV stabilized protective coating protects LEDs and circuitry for long term use in damp locations
- Connections may be separated and reconnected at each junction point
- Equal brightness for an entire light strip
- Strong adhesive bonding with the 3M adhesive VHB
- Gold plated snap-on connector protects from corrosion, heat, and ensures a reliable electrical connection
- 100ft max distance between the power supply and beginning of InvisiLED®

600 lumens	max run: 15 feet
400 lumens	max run: 20 feet
300 lumens	max run: 30 feet
200 lumens	max run: 40 feet
100 lumens	max run: 60 feet

ALL-IN-ONE CCT SELECTABLE

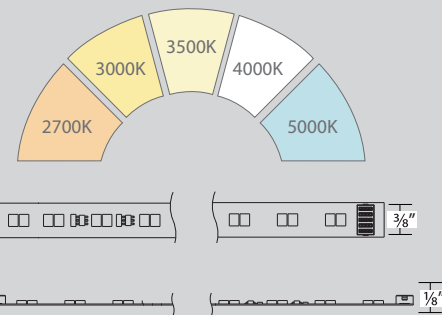

TAPE SELECTIONS

System	Max Run	Power	Length (in feet)	Color Temp	Finish
T24-CS1	100+lm/ft	60ft	1.2W/ft	01	05 10 20 60
T24-CS2	200+lm/ft	40ft	2.4W/ft	01	05 10 20 40
T24-CS3	300+lm/ft	30ft	3W/ft	01	05 10 20 30
T24-CS4	400+lm/ft	20ft	4.6W/ft	01	05 10 20 N/A
T24-CS6	600+lm/ft	15ft	6.3W/ft	01	05 10 15 N/A

Example: **T24-CS3-10-2750WT**

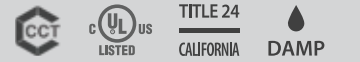

COMPATIBLE CLASS 2 POWER SUPPLY (REQUIRED)



- 7¹/₁₆" x 3⁷/₈" x 1³/₈"
- Universal Input, ≥ 0.9 pf
- Overload and short circuit protection

Model	Input	Output	Dimming
PS-24DC-U60R-CS-SM	120V-277V	24VDC 60W	ELV/0-10V
PS-24DC-U96R-CS-SM	120V-277V	24VDC 96W	ELV/0-10V

Includes 6ft lead wire with connector

ACCESSORIES

Type	Model	Finish
Tape to Tape Connector Connects tape sections	T24-MM	WT White
T Connector Connects tape sections	T24-TI	WT White
X Connector Connects tape sections	T24-XI	WT White
L Connector Connects tape sections	T24-LI	WT White
Joiner Cable Extender Connects joiner cable to joiner cable, female on both sides	T24-FF	WT White
Flex Y Connector Connects tape sections	T24-Y	WT BK White Black
Flex X Connector Connects tape sections	T24-X	WT BK White Black

Example: **T24-X-WT**

Type	Model	Finish
In-Wall Rated Joiner Cable Connects tape sections, 2 male ends	T24-IC-002 2 in	WT BK White Black
	T24-IC-006 6 in	
	T24-IC-012 1 ft	
	T24-IC-036 3 ft	
	T24-IC-072 6 ft	
	T24-IC-144 12 ft	
T24-IC-240 20 ft		

Example: **T24-IC-002-WT**

In-Wall Rated Extension Cable Extends distance between a hard wire power supply or a wiring box to a tape section	T24-EX3-072 6 ft	WT BK White Black
	T24-EX3-144 12 ft	
	T24-EX3-240 20 ft	
	T24-EX3-1200 100 ft	

Example: **T24-EX3-240-WT**

Step 1: Install WAC Power feed wiring box



Step 3: Cut channel and mount channel to studs without removing the foam insert



Step 5: Remove and discard foam insert and install InvisiLED® on one or both sides of the channel



Step 2: Cut out 2 3/8" wide and 5/8" deep opening to the length of the channel run



Step 4: Spackle, sand and paint around the soft strip channel



Step 6: For LED-T-RCH1-WT, snap in acrylic lens to finish

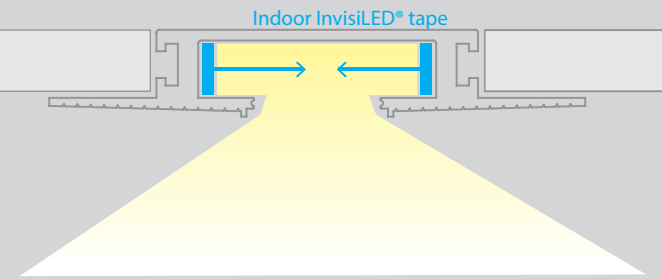

Installs within 5/8" drywall depth
 Linear channel can be field cut
 Accommodates either one or two runs of InvisiLED® indoor tape
 Includes a translucent white acrylic diffuser
 Dense foam insert to be removed in installation after spackling

8ft Linear Channel **LED-T-RCH1-WT**
 Includes: 1 diffuser
 8 perforated metal sheets

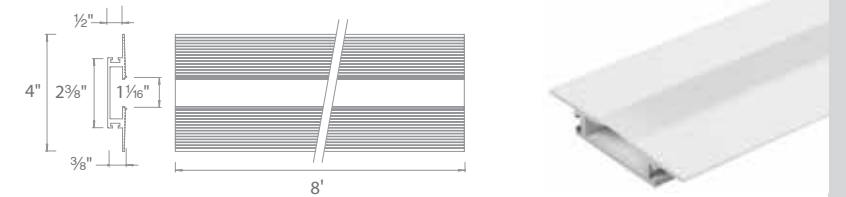

Power Feed **LED-T-RBOX1-WT**
 The end cap may be placed on either side
 Hanger bars may be installed on any side of the wiring box
 Kit includes: 1 wiring box
 2 hanger bars
 4 five-pin InvisiLED® adapters
 2 end cap
 1 diffuser
 2 channel connector
 1 counter sink drill bit
 1 drill bit
 1 installation tool

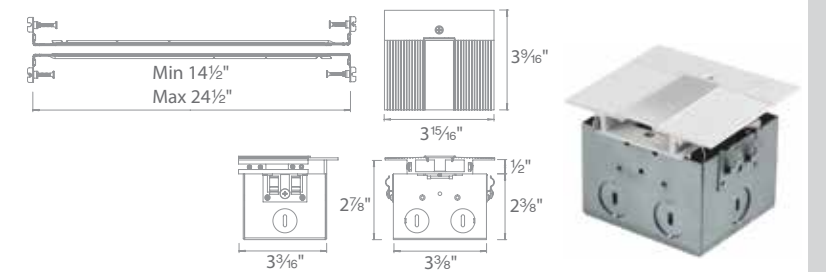

Lateral Corner **LED-T-CTC1-WT**
 Includes: Diffuser
 2 channel connectors
 2 perforated metal sheets

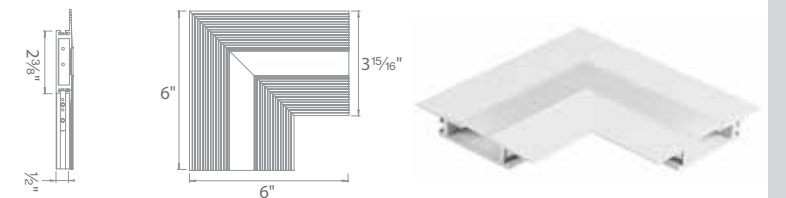

Perpendicular Corner **LED-T-WTC1-WT**
 Transitions between walls or wall to ceiling
 Includes: Diffuser
 2 channel connectors
 2 perforated metal sheets

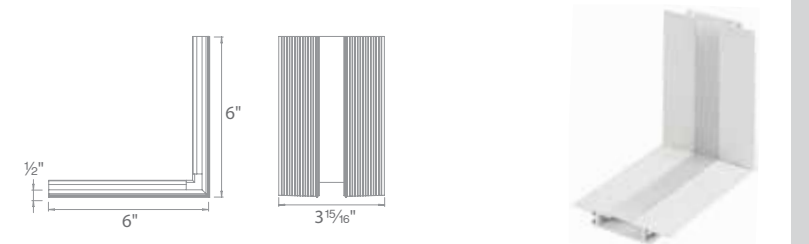

Outside Corner **LED-T-WTW1-WT**
 Transitions around columns, bump outs, or soffits
 Includes: Diffuser
 2 channel connectors
 2 perforated metal sheets

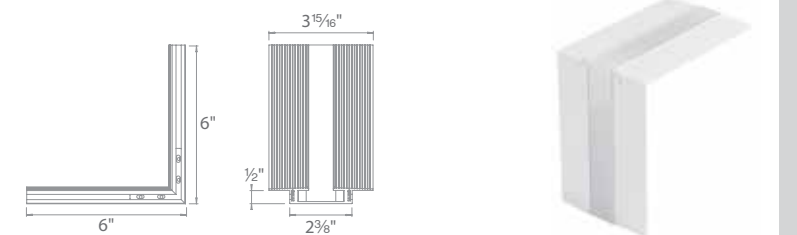

ASYMMETRICAL RECESSED CHANNEL

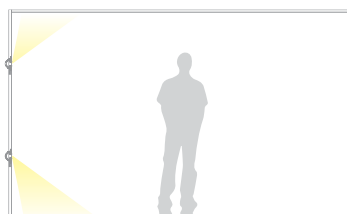

Installs within 5/8" drywall depth
 Linear channel can be field cut
 Accommodates one run of InvisiLED® indoor tape
 Dense foam insert to be removed in installation after spackling
 Recommended installation within 15 inches of surface to be illuminated

Indoor InvisiLED® tape

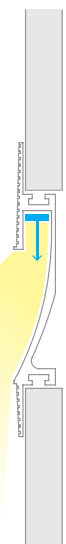

8ft Linear Channel **LED-T-RCH2-WT**

Includes: 8 perforated metal sheets
 2 channel connectors

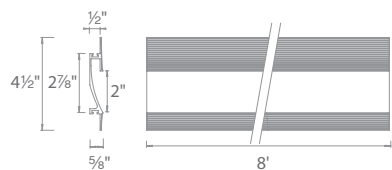

Power feed **LED-T-RBOX2-WT**

The end cap may be placed on either side
 Hanger bars may be installed on any side of the wiring box
 Includes: 1 wiring box
 2 hanger bars
 2 five-pin InvisiLED® adapters
 2 end caps (left and right)

2 channel connectors
 1 counter sink bit
 1 drill bit

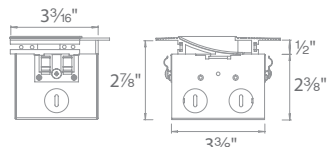
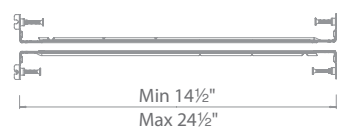
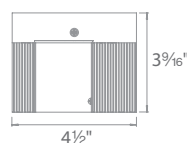

INDIRECT RECESSED CHANNEL

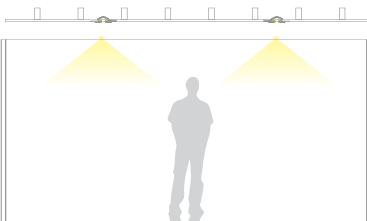

Linear channel can be field cut
 Accommodates up to four runs of InvisiLED® indoor tape
 Dense foam insert to be removed in installation after spackling
 Allows option to use different color InvisiLED® in one channel and switch them separately

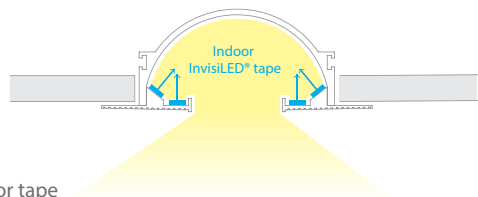

8ft Linear Channel **LED-T-RCH3-WT**

Includes: 10 perforated metal sheets
 2 channel connectors

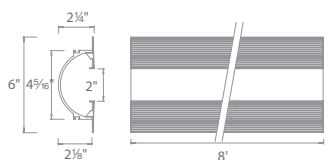

Power feed **LED-T-RBOX3-WT**

The end cap may be placed on either side
 Hanger bars may be installed on any side of the wiring box
 Includes: 1 wiring box
 2 hanger bars
 4 five-pin InvisiLED® adapters
 1 end cap

2 channel connectors
 1 counter sink drill bit
 1 drill bit

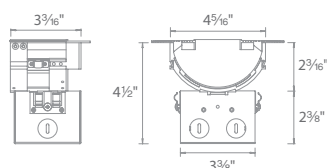
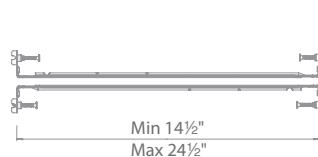
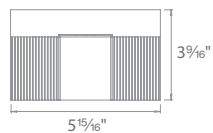

INDOOR ALUMINUM CHANNELS

COMPATIBLE WITH ALL DAMP RATED INVISILED® TAPE SYSTEMS

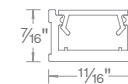

Aluminum Channel **LED-T-CH** 5 feet
 Additional End Caps **LED-T-CH-EC** 2 pcs

Diffuses light from InvisiLED® tape
 Includes a diffuser, two end caps, and five screws
 Compatible with InvisiLED® CCT, Pro, Pro2, Pro3, LITE

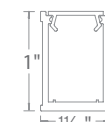

Deep Aluminum Channel **LED-T-CH1** 5 feet
 Additional End Cap **LED-T-CH1-EC** 2 pcs

Eliminates visible hot spots
 Includes a diffuser, two end caps, and five screws
 Compatible with InvisiLED® CCT, Pro, Pro2, Pro3, LITE



Installed with 45° Angled Aluminum Channel in toe kick and Pro 3 InvisiLED®

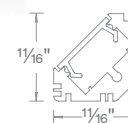

45° Angled Aluminum Channel **LED-T-CH2** 5 feet
 Additional End Caps **LED-T-CH2-EC** 2 pcs

Includes a diffuser, two end caps, and five screws
 Compatible with InvisiLED® CCT, Pro, Pro2, Pro3, LITE

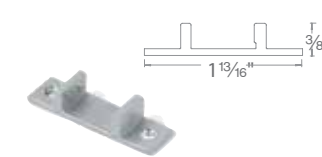

Fixed Channel Clip **LED-T-CL3-PT**

Includes 2 pieces, 4 screws. Use to mount Aluminum Channel, Deep Aluminum Channel, 45° Angled Aluminum Channel

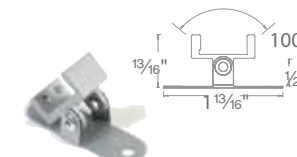

Adjustable Channel Clip **LED-T-CL2-PT**

INDOOR MOUNTING ACCESSORIES

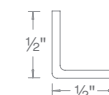

Aluminum Retrofit Channel **LED-T-RC** 3 feet

Can be bent to create fixed curves or used as a glare shield
 Compatible with Pro, Pro2, Pro3, LITE



Clear Channel **LED-TO24-CH5** 5 feet



Clip **LED-T-CL** 10 pcs
 For surfaces that are difficult to adhere 10 Screws

Clips to hold indoor InvisiLED® tapes sections
 Compatible with Pro, Pro2, Pro3, LITE



Curve Clip **LED-T-CL1** 10 pcs
 Secures on one edge 10 Screws

Clips to hold indoor InvisiLED® tapes sections
 Compatible with Pro, Pro2, Pro3, LITE



0.4" Actual size shown

Cut every 4 inches

Input: 24VDC
 Lumens: Up to 200 lm/ft
 Rated Life: 50,000 hours
 CRI: 90

- 100ft max distance between the power supply and beginning of InvisILED®, then power up to 80 feet of illumination per run. See chart for specification guide
- May be cut every 4 inches
- Beam Spread: 115°
- Multiple roll lengths offered
- Maintains the same brightness end to end even with voltage drop
- Protection against water spray and dust with silicone jacket (IP65)

TAPE SELECTIONS

System	Max Run	Power	Length (in feet)					Color Temp		Finish
T24-OD1	100+lm/ft	80ft	1.2W/ft	01	05	10	20	40	80	27 30 40 2700K 3000K 4000K Black
T24-OD2	200+lm/ft	40ft	2.4W/ft	01	05	10	20	40	N/A	

Example: **T24-OD1-20-27**

COMPATIBLE CLASS 2 POWER SUPPLY (REQUIRED)



- HARD WIRED POWER SUPPLY**
- 8 3/8" x 2 1/16" x 1 1/16"
 - Universal Input, ≥ 0.9 pf
 - Overload and short circuit protection

Model	Input	Output	Dimming
PS-24DC-U96R-WE	120V-277V	24VDC 96W	ELV/ TRIAC

Includes 6ft lead wire













- PORTABLE POWER SUPPLY**
- 8 3/8" x 2 1/16" x 1 1/16"
 - Power factor ≥ 0.9
 - Overload and short circuit protection

Model	Input	Output
PS-24DC-A96P-WE	120V	24VDC 96W

**Non-dimmable, includes 6ft power cord*

ACCESSORIES

Type	Model	Finish
 InvisILED Outdoor Joiner Cable Extends power supply lead wire	T24-WE-IC-002-BK	2 in
	T24-WE-IC-006-BK	6 in
	T24-WE-IC-012-BK	1 ft
	T24-WE-IC-036-BK	3 ft
	T24-WE-IC-072-BK	6 ft
	T24-WE-IC-144-BK	12 ft
 InvisILED Outdoor Lead Wire Connects to Indoor Power Supply	T24-WE-B012-BK	1 ft
	T24-WE-B072-BK	6 ft
 InvisILED Outdoor Power Connector Kit with Wire Jacket and Silicone Sealant Allows power to Wet Rated tape	T24-WE-EX2-006-BK	6 in
		Black
 InvisILED Outdoor Tape to Tape Y Connector Splits power to the two tape sections	T24-WE-Y-BK	Black
 Wet Rated Tape End Cap with Silicone Sealant 24VDC Wet Rated (10 pieces)	T24-WE-EC	Clear
 InvisILED Outdoor Surface Mounting Clip 24VDC Wet Rated Tape Mounting Screws (10 pieces)	LED-TO24-C1	Black
 InvisILED Outdoor Edge Mounting Clip 24VDC Wet Rated Tape Mounting Screws (10 pieces)	LED-TO24-C2	Black
 InvisILED Outdoor Underside Mounting Clip 24VDC Wet Rated Tape Mounting Screws (10 pieces)	T24-WE-C3	Black
 InvisILED Outdoor Surface Mount Clear Channel 5 ft sections. InvisILED Outdoor snaps in	T24-WE-CH5	Clear
 Silicone Sealant Wet Rated Listed Tape Sealant (45 grams)	T24-WE-SI-45	White

NEW

PIXELS CCT COLOR TEMPERATURE ADJUSTABLE LED LIGHT SHEET FOR BACKLIGHTING

Backlighting for curved or at surfaces with as little as 1" recessed depth. Cut around obstacles, such as plumbing, when backlighting a countertop with a sink. Installs like a dream with modular 12"x24" sheets that can be cut-to-fit with scissors.



Connectors
Powers easily by daisy chaining with connectors or at soldering points



Flexibility
Lightweight, ultra-thin 1/8 inch profile navigates curves for various applications



Convenient Mounting
Can be stapled, tacked or nailed to curved or flat wall and ceiling surfaces



CCT Power Supply
Select desirable CCT with matching power supply



3M Backing
Adheres easily to most surfaces for reliable installation



Field-Cuttable
Cuts vertically or horizontally in unique configurations and around obstacles

PIXELS CCT
COLOR TEMPERATURE ADJUSTABLE LED LIGHT SHEET FOR BACKLIGHTING



ALL-IN-ONE CCT SELECTABLE

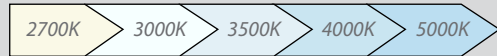

DISCREET

Hides inside walls and ceilings at 1/8" thin with LEDs spaced on 1" center

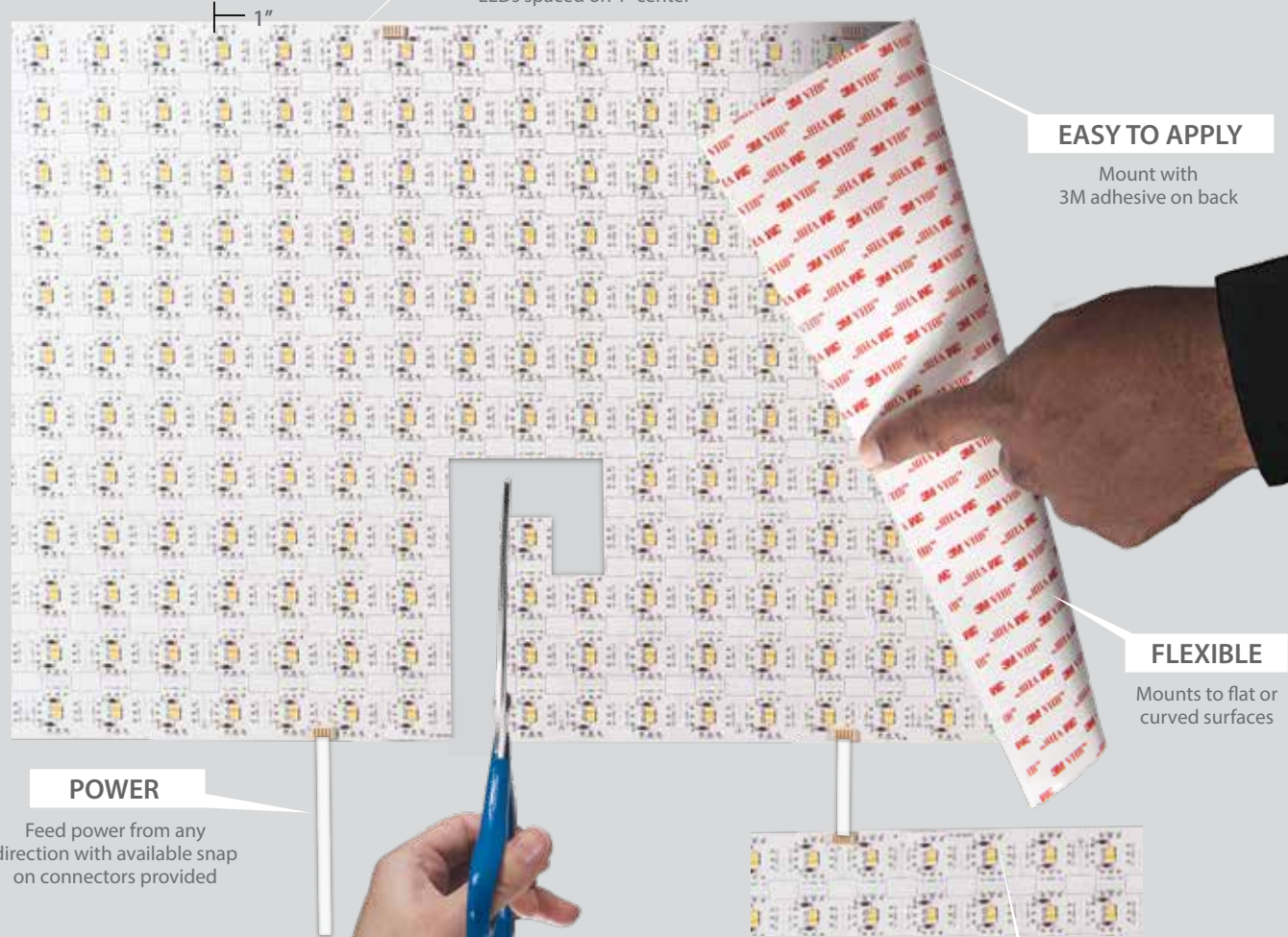

EASY TO APPLY

Mount with 3M adhesive on back

FLEXIBLE

Mounts to flat or curved surfaces

POWER

Feed power from any direction with available snap on connectors provided

CUSTOMIZE

Create exact shapes you want by cutting along dotted lines

ADD

Modular and scalable

Input: 24VDC
CRI: 90
Rated Life: 50,000 hours

Versatile mounting options:

- 3M-construction adhesive adheres to most surfaces (flat or curved)
- Can be installed in either exposed or fully enclosed spaces
- Specially rated for installation in the storage area of a clothes closet
- With a lightweight, ultra-thin 1/8" profile, Pixels requires very little space
- Add & select and choose desirable CCT with matching CCT select power supply
- Even illumination of translucent surfaces from as little as 1 1/2" behind
- May be field-cut vertically or horizontally, in unique shapes or around obstructions
- Powers easily by daisy chaining with gold plated connectors or power from any square at soldering points provided

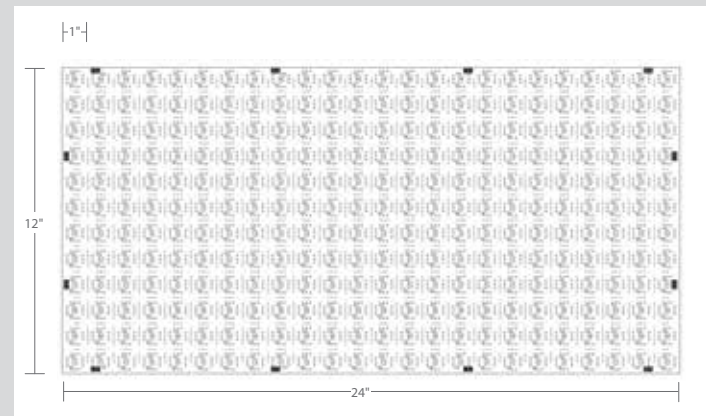

PIXELS CCT
COLOR TEMPERATURE ADJUSTABLE LED LIGHT SHEET FOR BACKLIGHTING



Model	Dimension	LED Lumens	Watt	Color Temp	Color
LED P05 P10	1224 12" x 24"	500 lm/sq ft 1000 lm/sq ft	5W/sq ft 10W/sq ft	2750 2700K 3000K 3500K 4000K 5000K	White

Example: **LED-P10-1224-2750**

ACCESSORIES

	Type	Model	Finish	Size
	Joiner Cable <i>Connects between Pixels</i>	T24-MM-002 T24-MM-006	WT	White 2 in 6 in
	I Connector <i>Connects between Pixels</i>	T24-MM-FLEX	WT	White
	PIXELS Connector <i>Connects Pixels sections</i>	T24-MM	WT	White
	T Connector <i>Connects Pixels sections</i>	T24-TI	WT	White
	X Connector <i>Connects Pixels sections</i>	T24-XI	WT	White
	L Connector <i>Connects Pixels sections</i>	T24-LI	WT	White
	Joiner Cable Extender <i>Connects joiner cable to joiner cable, female on both sides</i>	T24-FF	WT	White
	Y Connector <i>Connects Pixels sections</i>	T24-Y	WT BK	White Black
	X Connector <i>Connects Pixels sections</i>	T24-X	WT BK	White Black

Example: **T24-X-WT**

	Type	Model	Finish
	In-Wall Rated Joiner Cable <i>Connects Pixels sections, 2 male ends</i>	T24-IC-002 2 in T24-IC-006 6 in T24-IC-012 1 ft T24-IC-036 3 ft T24-IC-072 6 ft T24-IC-144 12 ft T24-IC-240 20 ft	WT White BK Black

Example: **T24-IC-002-WT**

	Type	Model	Finish
	In-Wall Rated Extension Cable <i>Extends distance between a hard wire power supply or a wiring box to a Pixels section</i>	T24-EX3-072 6 ft T24-EX3-144 12 ft T24-EX3-240 20 ft T24-EX3-1200 100 ft	WT White BK Black

Example: **T24-EX3-240-WT**

COMPATIBLE CLASS 2 POWER SUPPLY (REQUIRED)

Model	Input	Output	Dimming
PS-24DC-U60R-CS-SM	120V-277V	24VDC 60W	ELV/0-10V
PS-24DC-U96R-CS-SM	120V-277V	24VDC 96W	ELV/0-10V

Includes 6ft lead wire with connector

- 7 1/8" x 3 7/8" x 1 3/8"
- Universal Input, ≥ 0.9 pf
- Overload and short circuit protection

CUBE ARCHITECTURAL RGBAW



5" CUBES

Input: 120-277V
 CRI: 90+
 Rated Life: 50,000 hours

- Full gamut of saturated colors (380-780nm)
- Tunable white (CCT) range: 1650-8000K
- Connect via Bluetooth using ilumenight iOS app
- Compatible with DMX-512A for advanced color controls
- High-performance LED wall mount light
- Solid aluminum construction
- Fixture can be installed up or downward to alter light distribution



Color changable with ilumenight iOS app



DC-WS05



DC-WD05

Model	Size	Power	Max Delivered Lumens at 3000K	CBCP at 3000K	Beam	Light Direction	Color Temp	Finish
Single DC-WS05	5"	31W	735	6177	S N F 15° 25° 30°	S Straight up or down	CC Color Changing	BK Black WT White BZ Bronze GH Graphite
						A Away from the wall		
						B Towards the wall		
Double DC-WD05	5"	31W x2	840 x2	—	F 15° 25° 30°	S Straight up or down	CC Color Changing	BK Black WT White BZ Bronze GH Graphite
						A Away from the wall		
						B Towards the wall		
Double DC-WD05	5"	31W x2	840 x2	—	F 15° 25° 30°	C One side each	CC Color Changing	BK Black WT White BZ Bronze GH Graphite
						A Away from the wall		
						B Towards the wall		

Example: DC-WD05-FA-CC-BK

CUBE ARCHITECTURAL RGBAW



5" CUBES

Input: 120-277V
 CRI: 90+
 Rated Life: 50,000 hours

- Full gamut of saturated colors (380-780nm)
- Tunable white (CCT) range: 1650-8000K
- Connect via Bluetooth using ilumenight iOS app
- Compatible with DMX-512A for advanced color controls
- High-performance LED surface and pendant lights
- Solid aluminum construction
- DC-PD05 includes 45° swivel canopy and two field-cutable 24" rods



Color changable with ilumenight iOS app



DC-CD05



DC-PD05

Model	Size	Power	Beam	Delivered Lumens at 3000K	CBCP at 3000K	Color Temp	Finish
Ceiling DC-CD05	5"	31W	S N F 15° 25° 30°	735 645 620	6177 1951 1386	CC Color Changing	BK Black WT White BZ Bronze GH Graphite
Pendant DC-PD05	5"	31W	S N F 15° 25° 30°	735 645 620	6177 1951 1386	CC Color Changing	BK Black WT White BZ Bronze GH Graphite

Example: DC-PD05-S-CC-GH

MOUNTING ACCESSORY

	Extension Rod for pendant mount	DS-PDX24	24" extension rod. Can be field cut Fixture may be extended up to 96" total	BK Black WT White BZ Bronze GH Graphite
--	---------------------------------	----------	---	--

Example: DS-PDX24-WT

STEP LIGHTS WITH INTEGRAL PHOTOCELL

Energy saving photocell sensor activates LEDs when it's dark, and automatically powers off when there is ambient light.



Good for indoor and outdoor applications

Fits into 2"×4" switch box

STEP LIGHTS WITH INTEGRAL PHOTOCELL



Input: 120V
Power: 2W
Lumens: Up to 65lm
CRI: 90+
Rated Life: 54,000 hours

- *Anti-microbial white powder coat paint proven to restrain a wide range of bacteria, fungus, and algae
- Options in die-cast brass or 316 marine-grade stainless steel
- Fits into 2"×4" J-Box with minimum inside dimensions of 3"×2"×2"
- No driver needed
- No heat radiation
- IP66, Wet Location Listed rated for indoor and outdoor installations

System	Color	Finish
	30 Pure White 3000K (CCT) AM Amber 610nm (Peak)	BK Black on Aluminum BN** Brushed Nickel on Aluminum BZ Bronze on Aluminum SS Stainless Steel WT White on Aluminum
	WL-LED103 120V Horizontal Scoop	30 Pure White 3000K (CCT) AM Amber 610nm (Peak)
	30 Pure White 3000K (CCT) AM Amber 610nm (Peak)	BK Black on Aluminum BN** Brushed Nickel on Aluminum BZ Bronze on Aluminum SS Stainless Steel WT White on Aluminum
	WL-LED203 120V Vertical Scoop	30 Pure White 3000K (CCT) AM Amber 610nm (Peak)

Example: **WL-LED103-30-WT**

**BN Finish is not warranted for contact with chemicals or exterior installations. Use Stainless Steel Step and Wall Lights for harsh outdoor environments.



WAC LANDSCAPE LIGHTING

Your vision. Our solutions. Let's paint with light.

An extension of our world-class lighting technology brand, WAC Landscape Lighting offers groundbreaking, patented lighting instruments for your entire outdoor canvas. State of the art innovations address challenges that have not been previously confronted. As a design-and-build manufacturer, WAC builds long-term relationships with landscape contractors, designers and architects by solving the challenges they face with creativity and innovation. Over the years, professionals have entrusted our company to provide cutting-edge technology and superior quality.

Landscape products are subjected to rigorous testing including water/dust intrusion, mechanical, environmental and aging. All tests are conducted in an internationally recognized NVLAP, UL, ETL, and Energy Star certified testing laboratory for safety, durability and robust performance far beyond required standards. We perform this testing concurrent with engineering to develop reliable products quickly for you.

From wall washers and accent lights, to in-ground and underwater spots, to outdoor tape, hardscape, step and path lights, we offer a plethora of choices for every designer or installer. The WAC style is sleek and stylish, making the brand an ideal choice for pairing fixtures with your exterior while providing all the light that you will ever need as your landscape matures. For more information, visit WACLandscapeLighting.com.



LINEAR PATH LIGHT LED LANDSCAPE



12V

- Low profile and discreet
 - 180° fully rotatable fixture aiming
 - Lock desired position in place after adjustment
 - Wide Flood Beam 110° x 80°
 - Adjustable anti-glare shroud
 - Designed for soft ground, wood floor and concrete
 - Base mount, riser mount & extension mount
 - Path & Accent applications
- Transformer Required (order separately)*



Input: 9-15V
Power: 6.0W/8.6VA
Brightness: 190lm
Beam Angle: 110° x 80°
CRI: 85
Rated Life: 60,000 hours

Model	Color	Finish
6401-27	2700K	BZ Bronze on Aluminum
6401-30	3000K	BZ Bronze on Aluminum

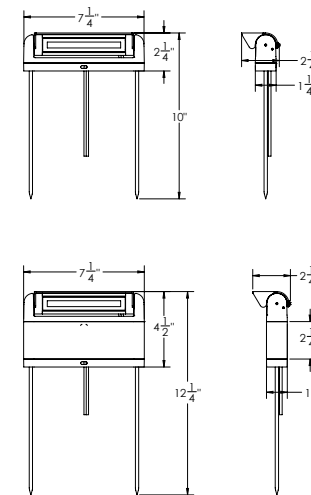



Optional riser attachment included



Extension Mount
(Order extension rods separately)

Accessories

9" Mounting Stake		9000-ST9-BZ	Bronze	Durable PC stake
Extension Rods		5000-X04-BZ 5000-X08-BZ 5000-X12-BZ 5000-X18-BZ 5000-X24-BZ	4 in 8 in 12 in 18 in 24 in	Bronze Extends distance between Accent light and surface mount canopy, stake, or tree mount box

Detachable shroud, 10' lead wire and direct burial gel filled wire nuts (12V).

GRAND WALL WASH LED LANDSCAPE

WITH INTEGRAL BEAM AND BRIGHTNESS CONTROL

- IP66 Rated, protected against powerful water jets
- Solid die-cast brass or corrosion resistant aluminum alloy

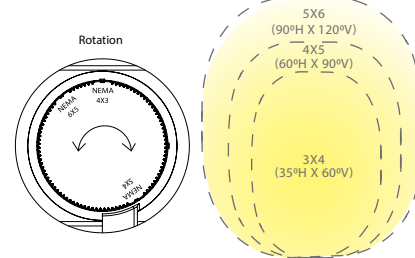
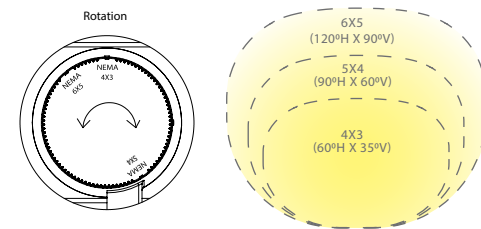

Architectural beam distributions from 3x4 to 4x5 to 5x6 proportions and everything in between. Always a uniform wide beam wash of light.

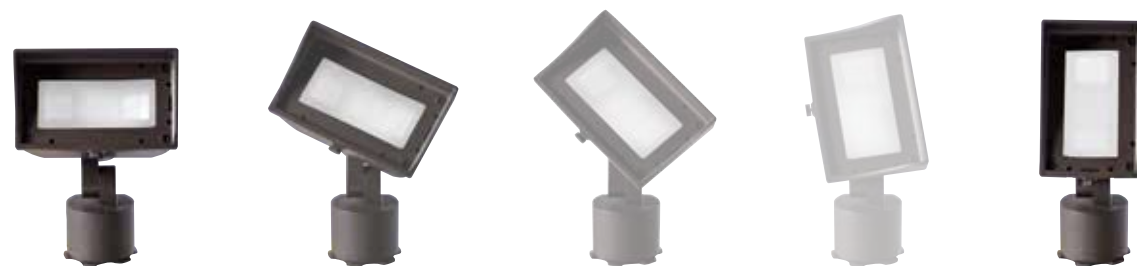

NEMA 5x4 → NEMA 4x5

GRAND WALL WASH LED LANDSCAPE

WITH INTEGRAL BEAM AND BRIGHTNESS CONTROL



12V

- Continuously adjustable NEMA beam
- Distribution 3x4 (35°x60°), 4x5 (60°x90°), 5x6 (90°x120°)
- Both fixture level dimming and circuit level dimming
- Dim each circuit from either the 12V or 120V side
- Rotatable fixture head for vertical distribution

Transformer Required (order separately)

Input: 9-15V
Power: 3W to 25W/4.4VA-27.8VA
Brightness: 200lm to 1500lm
Beam Angle: Assorted NEMA distributions
CRI: 85
Rated Life: 70,000 hours

Model	Color	Finish
5221-27	2700K	BK Black on Aluminum
		BZ Bronze on Aluminum
		BBR Bronze on Brass
5221-30	3000K	BK Black on Aluminum
		BZ Bronze on Aluminum
		BBR Bronze on Brass

120V

- Continuously adjustable NEMA beam
- Distribution 3x4 (35°x60°), 4x5 (60°x90°), 5x6 (90°x120°)
- Both fixture level dimming and circuit level dimming
- Dim each circuit with a magnetic line voltage dimmer or control system
- Simple to retrofit existing line voltage systems or coordinate well with a new commercial landscape project

Input: 110V-120V
Power: 3W to 25W
Brightness: 200lm to 1550lm
Beam Angle: Assorted NEMA distributions
CRI: 85
Rated Life: 45,000 hours

Model	Color	Finish
5222-27	2700K	BK Black on Aluminum
		BZ Bronze on Aluminum
		BBR Bronze on Brass
5222-30	3000K	BK Black on Aluminum
		BZ Bronze on Aluminum
		BBR Bronze on Brass

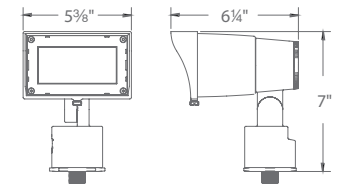

Architectural beam distributions from 3x4 to 4x5 to 5x6 proportions and everything in-between. Always a uniform wide beam wash of light.

Accessories

14" Mounting Stake		9000-ST14-BZ	Bronze	Durable PC stake				
Surface Mount Flange/Stake		5000-SCP-BK 5000-SCP-BZ 5000-SCP-BBR	Black on Aluminum Bronze on Aluminum Bronze on Brass	Includes three 7-inch threaded stainless steel stabilizing pins for ground mounting or surface mounts with four screws or over a junction box				
Guardian Mount		9000-SP9-BZ	Stainless Steel	Heavy duty stainless steel spike to position fixture				
Gutter Mount Bracket		5000-GM-BK 5000-GM-BZ	Black on Aluminum Bronze on Aluminum	Stainless steel universal mounting bracket for gutter mounting fixture				
Tree Mount Junction Box		5000-TCP-BK 5000-TCP-BZ	Black on Aluminum Bronze on Aluminum	Aluminum box with stainless steel mounting screws; two 1/2" NPT threaded holes, UL 120V listed				
		5000-TCL-BK 5000-TCL-BZ	Black on Aluminum Bronze on Aluminum	Large Aluminum box with stainless steel mounting screws; two 1/2" NPT threaded holes, UL 120V listed				
Large Tree Mount Canopy Strap		5000-TST-BK	Black on Steel/terylene	Ratcheting device with strap for use with Tree Mount Junction Box (5000-TCL)				
		5000-STB-BK	Black on Steel	Tree mount bracket only				
Optics		LENS-3X5-AMB LENS-3X5-GRN LENS-3X5-RED	Amber Green Red	LENS-3X5-BLU LENS-3X5-FR LENS-3X5-SPR	Blue Frosted Spread	LENS-3X5-BEL	Beam Elongating	Enhances saturation of florals and foliage

14" Mounting stake (12V), detachable shroud, 6' lead wire and direct burial gel filled wire nuts (12V) or standard wire nuts (120V) included

NEW

ACCENT LED LANDSCAPE WITH INTEGRAL BRIGHTNESS CONTROL

UL US
1838 listed
1598 listed
IP66



- Fixture-Level Dimming Onboard
- Circuit-Level Dimming

Maintain intentional differences in brightness between fixtures with dimmers or smart-home control systems.

Awarded with several patented inventions, the WAC LED Accent replaces the functionality of all older halogen landscape accent lights while recouping energy efficiencies. Key innovations engineered around dimming control and beam adjustment have made it possible for a single LED landscape lighting instrument to satisfy all of the accent illumination needs of a project.

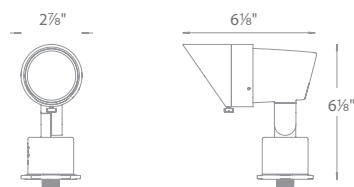

YOUR FAVORITE ACCENT LIGHT HAS BEEN MADE EVEN BETTER

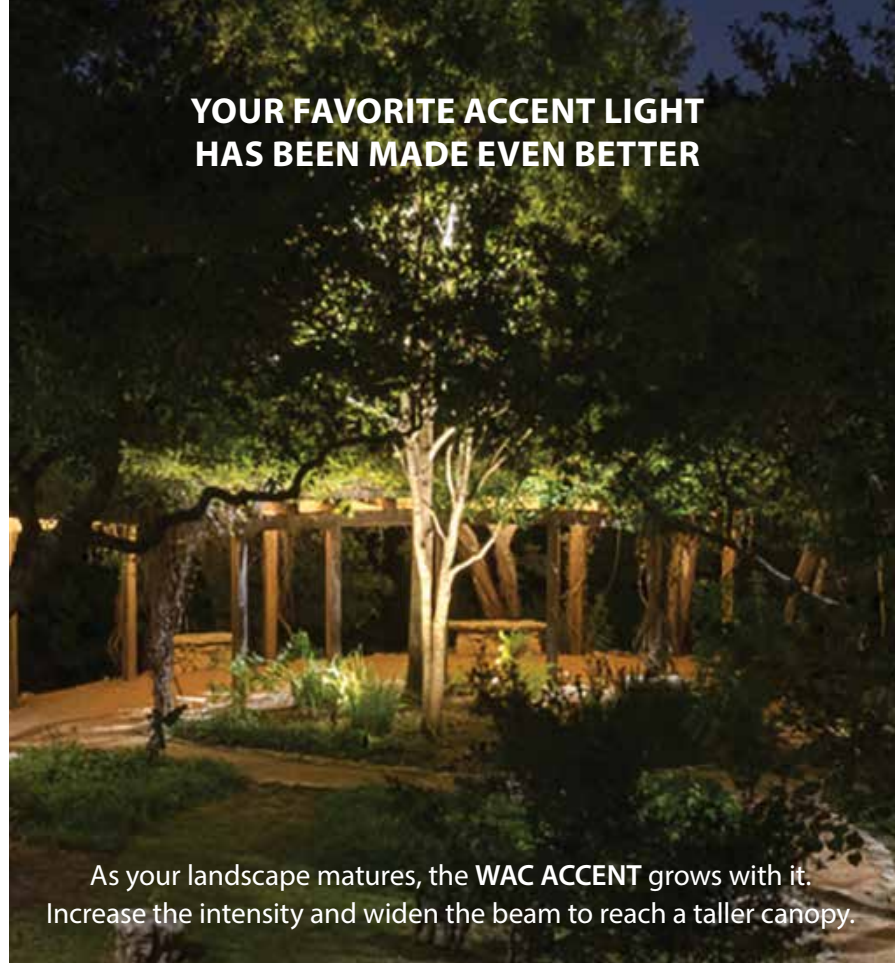

As your landscape matures, the WAC ACCENT grows with it. Increase the intensity and widen the beam to reach a taller canopy.

12V

- Both fixture level dimming and circuit level dimming
- Dim each circuit from either the 12V or 120V side
- Adjustable beam angle 10° to 60°

Input	9-15V
Power	1W to 18W/2VA-23VA
Brightness	50lm to 1160lm
Beam Angle	10° to 60°
CRI	85
Rated Life	70,000 hours

5011-27	2700K	BK	Black on Aluminum
5011-30	3000K	BZ	Bronze on Aluminum
5011-40	4000K	BBR	Bronze on Brass

120V

- Both fixture level dimming and circuit level dimming
- Dim each circuit with a magnetic line voltage dimmer or control system
- Adjustable beam angle 15° to 60°
- Simple to retrofit existing line voltage systems or coordinate well with a new commercial landscape job

Input	110V-120V
Power	3.5W to 14.5W
Brightness	100lm to 900lm
Beam Angle	15° to 60°
CRI	85
Rated Life	45,000 hours

5012-30	3000K	BK	Black on Aluminum
		BZ	Bronze on Aluminum
		BBR	Bronze on Brass

Glare Control and Optics

6" Long Shroud		5010-LSHR-BK 5010-LSHR-BZ 5010-LSHR-BBR	Black on Aluminum Bronze on Aluminum Bronze on Brass	Reduce glare; ideal for downlighting application
Accent Snoot		5010-SNOOT-BK 5010-SNOOT-BZ 5010-SNOOT-BBR	Black on Aluminum Bronze on Aluminum Bronze on Brass	Reduce glare; ideal for downlighting application
Optics		LENS-20-AMB LENS-20-GRN LENS-20-RED	Amber Green Red	LENS-20-BLU Blue LENS-20-FR Frosted LENS-20-SPR Spread
		5011-HCL LENS-20-BEL	Honeycomb Lens Beam Elongating	

Mounting stake (12V), Detachable shroud, 6' lead wire and direct burial gel filled wire nuts (12V) or standard wire nuts (120V) included
Additional mounting accessories available, see page 51

ACCENT LED LANDSCAPE

General Mounting Accessories

9" Mounting Stake		9000-ST9-BZ	Bronze	Durable Polycarbonate stake
14" Mounting Stake		9000-ST14-BZ	Bronze	Durable Polycarbonate stake
Power Stake		M6000-STAKE	Black	Easy wiring accessory designed for 120V products; eliminates the need for a separate J-box.
Guardian Mount		9000-SP9-BZ	Stainless Steel	Heavy duty stainless steel spike to position fixture; formed from a single piece of metal
Gutter Mount Bracket		5000-GM-BK 5000-GM-BZ	Black on Stainless Steel Bronze on Stainless Steel	Stainless steel universal mounting bracket for gutter mounting fixture
Tree Mount Junction Box		5000-TCP-BK	Black on Aluminum	Aluminum box with stainless steel mounting screws; two 1/2" NPT threaded holes
		5000-TCP-BZ	Bronze on Aluminum	
Large Tree Mount Canopy Strap		5000-TCL-BK	Black on Aluminum	Large Aluminum box with stainless steel mounting screws; two 1/2" NPT threaded holes
		5000-TCL-BZ	Bronze on Aluminum	
Large Tree Mount Canopy Strap		5000-TST-BK	Black on Steel/terylene	Ratcheting device with strap for use with Tree Mount Junction Box (5000-TCL)
		5000-STB-BK	Black on Steel	Tree mount bracket only

INTERBEAM

12V

- Dim multiple accent lights with remote Magnetic Low Voltage dimmer
- Adjustable beam angle 20° to 60°
- One adjustable light replaces many fixed lights

Input	9-15V
Power	6W/7.7VA
Brightness	475lm
Beam Angle	20° to 60°
CRI	85
Rated Life	70,000 hours

5311-27	2700K	BK	Black on Aluminum
		BZ	Bronze on Aluminum

5311-30	3000K	BK	Black on Aluminum
		BZ	Bronze on Aluminum

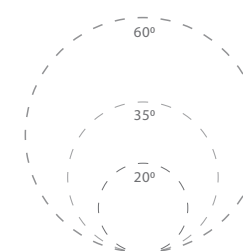
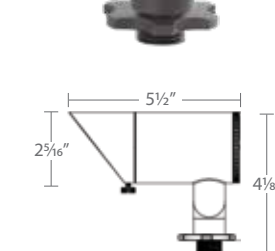

Glare Control and Optics

5" Long Shroud		5111-LSHR-BK 5111-LSHR-BZ	Black on Aluminum Bronze on Aluminum	Reduce glare; ideal for downlighting application
Mini Accent Snoot		5111-SNOOT-BK 5111-SNOOT-BZ	Black on Aluminum Bronze on Aluminum	Reduce glare; ideal for downlighting application
Optics		LENS-16-AMB LENS-16-GRN LENS-16-RED	Amber Green Red	LENS-16-BLU Blue LENS-16-FR Frosted LENS-16-SPR Spread
		5111-HCL LENS-16-BEL	Honeycomb Lens Beam Elongating	

Mounting stake (12V), detachable shroud, 6' lead wire and direct burial gel filled wire nuts (12V) included

HARDSCAPE LED LANDSCAPE
 QUICK RELEASE LIGHT ENGINE, DUAL CCT AND INTEGRAL BRIGHTNESS CONTROL

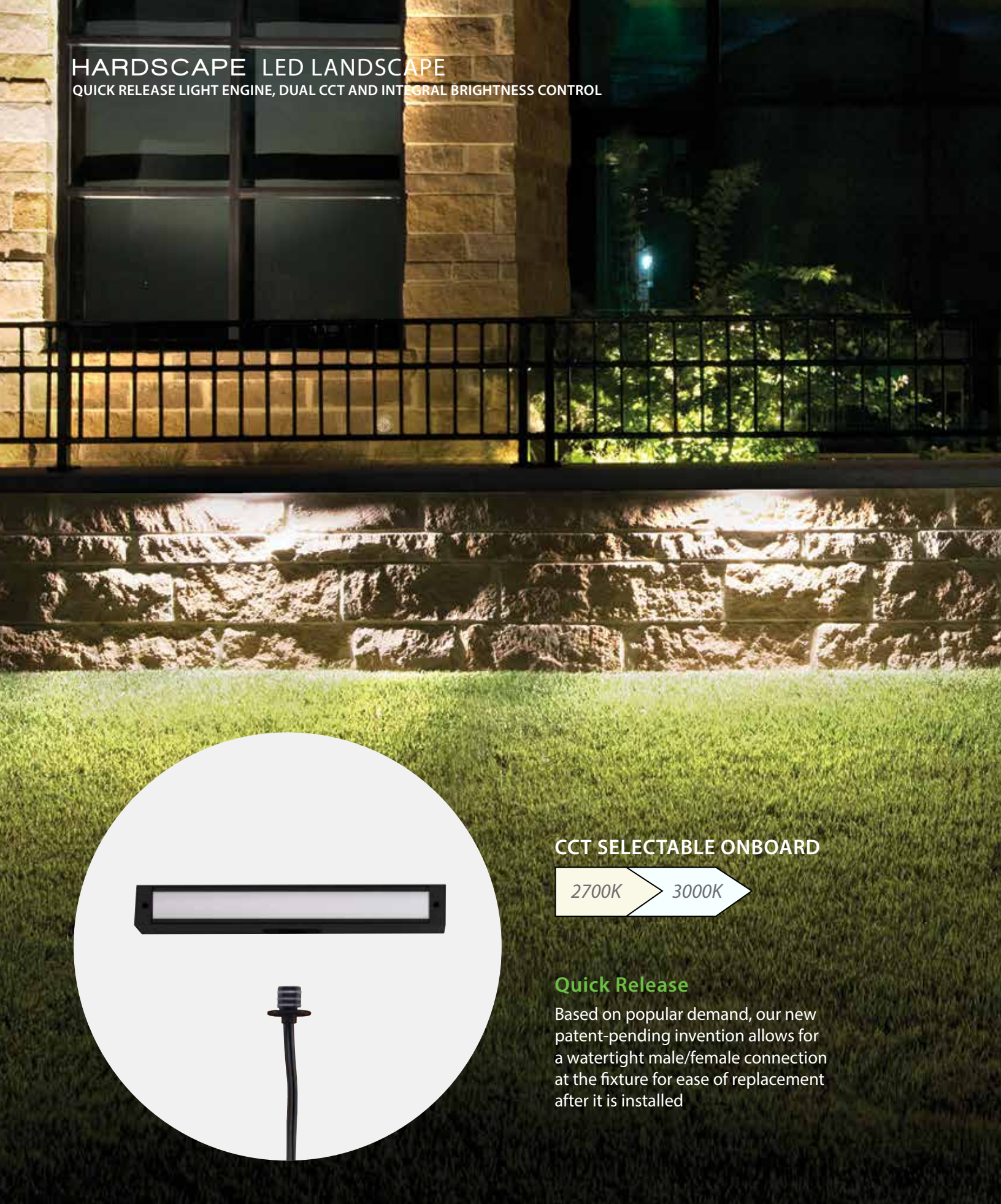

CCT SELECTABLE ONBOARD

2700K 3000K

Quick Release

Based on popular demand, our new patent-pending invention allows for a watertight male/female connection at the fixture for ease of replacement after it is installed

HARDSCAPE LED LANDSCAPE
 QUICK RELEASE LIGHT ENGINE, DUAL CCT AND INTEGRAL BRIGHTNESS CONTROL



12V

- Quick Release connection at fixture to easily detach from capstone bracket after installation
- Integral Brightness control
- Select Color Temperature in the field
- Corrosion-resistant aluminum alloy
- Factory-sealed watertight fixture
- Transformer required (sold separately)
- Tightly spaced and diffused LEDs for even illumination
- 6' lead wire and direct burial gel-filled wire nuts included
- Patents pending

Input: 9-15V
Beam Angle: 110°
CRI: 85
Rated Life: 70,000 hours

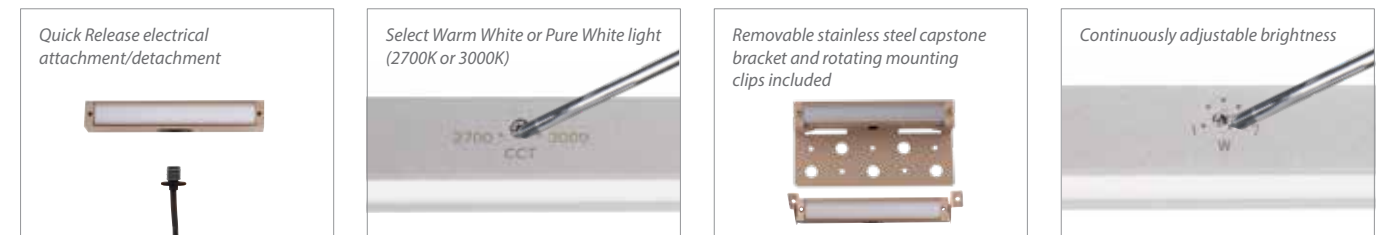
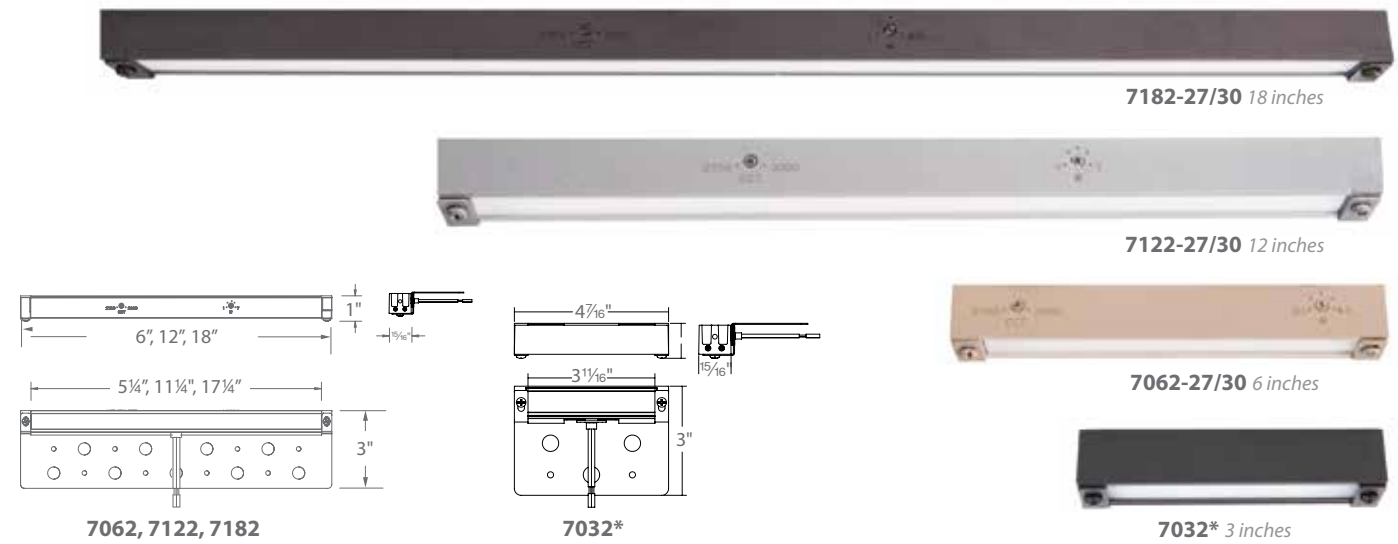

Length	Model	Color Temp	Wattage	Max Lumens	Finishes
3"	7032-27 7032-30	2700K Warm White* 3000K Pure White*	1.5W, 2.6VA	50	BK Black on Aluminum BZ Bronze on Aluminum GH Graphite on Aluminum SD Sand on Aluminum
6"	7062-27/30	2700K Warm White 3000K Pure White	4.5W, 5.6VA	110	BK Black on Aluminum BZ Bronze on Aluminum BBR Bronze on Brass GH Graphite on Aluminum SD Sand on Aluminum
12"	7122-27/30	2700K Warm White 3000K Pure White	7.0W, 7.6VA	230	BK Black on Aluminum BZ Bronze on Aluminum BBR Bronze on Brass GH Graphite on Aluminum SD Sand on Aluminum
18"	7182-27/30	2700K Warm White 3000K Pure White	8.5W, 9.3VA	350	BK Black on Aluminum BZ Bronze on Aluminum GH Graphite on Aluminum SD Sand on Aluminum

Example: **7182-27/30SD**

*Due to its compact size, the 7032 is dedicated in either 2700K or 3000K.

CANOPY LED AREA LIGHT



- Sturdy side mount design works well in applications where directional illumination is desired
- Recommended spacing for installation:
Residential: 7 to 9ft
Commercial: 5 to 7ft

Input 9-15V
Power 6.5W/9.5VA
Brightness Up to 225 lm
Color Temp 2700 & 3000K
CRI 90
Rated Life 60,000 hours

8" CAP

2700 & 3000K Warm and Pure White

6051-27 **BK** Black on Aluminum
6051-30 **BZ** Bronze on Aluminum
BBR Bronze on Brass

6" CAP

2700 & 3000K Warm and Pure White

6053-27 **BK** Black on Aluminum
6053-30 **BZ** Bronze on Aluminum
BBR Bronze on Brass

EXAMPLE: 6051-30BZ

Mounting stake, 6 foot lead wire, and direct burial gel filled wire nuts included

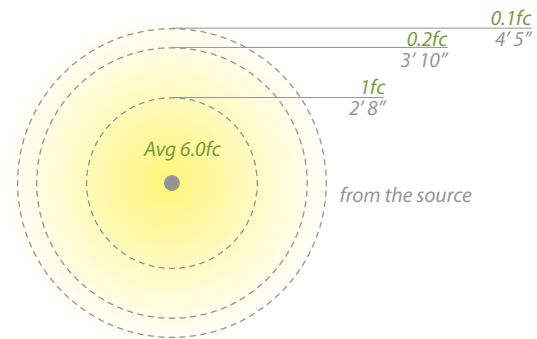

Accessories

9" Mounting Stake		9000-ST9-BZ	Bronze	Durable PC stake
14" Mounting Stake		9000-ST14-BZ	Bronze	Durable PC stake
Surface Mount Flange/Stake		5000-SCP-BK 5000-SCP-BZ 5000-SCP-BBR	Black on Aluminum Bronze on Aluminum Bronze on Brass	Includes three 7-inch threaded stainless steel stabilizing pins for ground mounting or surface mounts with four screws or over a junction box
Guardian Mount		9000-SP9-BZ	Stainless Steel	Heavy duty stainless steel spike to position fixture; formed from a single piece of metal

SURFACE MOUNTED STEP LIGHT LED LANDSCAPE



LOW PROFILE INSTALLATION

- Slim, low profile design-surface mount installation
- Junction box not required
- Die-cast aluminum or die-cast brass
- Invisible hardware
- 6' lead wire included
- Compatible with WAC 12V Landscape Transformers (sold separately)

4501

Input: 9-15V
Power: 4W/6.5VA
Brightness: 55 lm
Color Temp: 2700K Warm white, 3000K Pure white
CRI: 90
Rated Life: 70,000 hours

Model	Color	Finish
4501-27	2700K	BK Black on Aluminum
		BZ Bronze on Aluminum
		WT White on Aluminum
4501-30	3000K	BK Black on Aluminum
		BZ Bronze on Aluminum
		BBR Bronze on Brass

4901

Input: 9-15V
Power: 8W/12VA
Brightness: 100 lm
Color Temp: 2700K Warm white, 3000K Pure white
CRI: 90
Rated Life: 70,000 hours

Model	Color	Finish
4901-27	2700K	BK Black on Aluminum
		BZ Bronze on Aluminum
		BBR Bronze on Brass
4901-30	3000K	BK Black on Aluminum
		BZ Bronze on Aluminum
		BBR Bronze on Brass

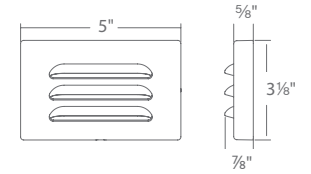

4501-27

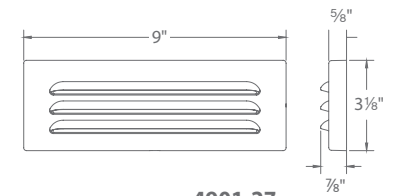

4901-27

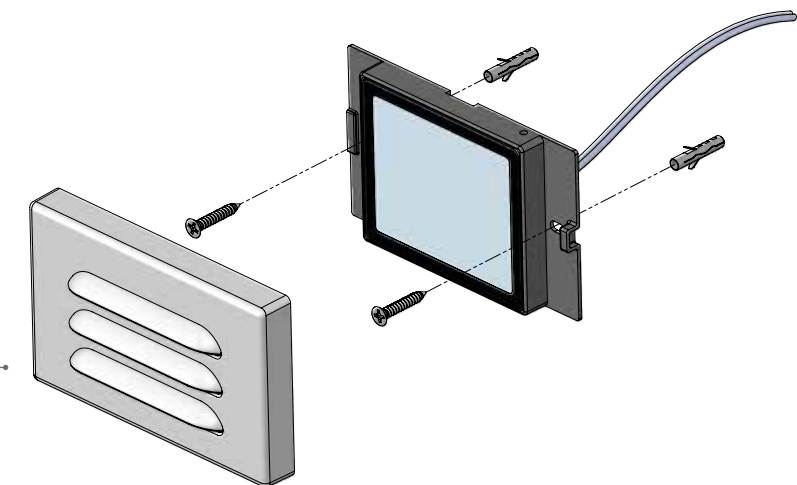

Fixture can be mounted directly to the wall without a junction box



WAC LIMITED

Maximize desirability and minimize expenses with WAC Limited lighting products designed to accommodate both single-family or multifamily housing projects and large-scale apartment complexes and hotel guestrooms. Lighting a home well elevates the perceived value of all finishes used and increases functionality of spaces while also minimizing maintenance and energy expenses.

Dollar for dollar, quality lighting improves occupant experiences more than any other construction material. Our wide array of products cover kitchens, baths, bedrooms, closets, hallways, living rooms, laundry rooms, and garages—all designed for safety and proven to last.

We also understand that installation costs are a major part of the value equation. As such, WAC Limited lighting products are engineered to minimize installation time and the associated hidden costs. Higher-end lighting products and designs can be found in the WAC Lighting and dweLED product lines where the needs may arise.

BASICS TAPE CUT AND CONNECT

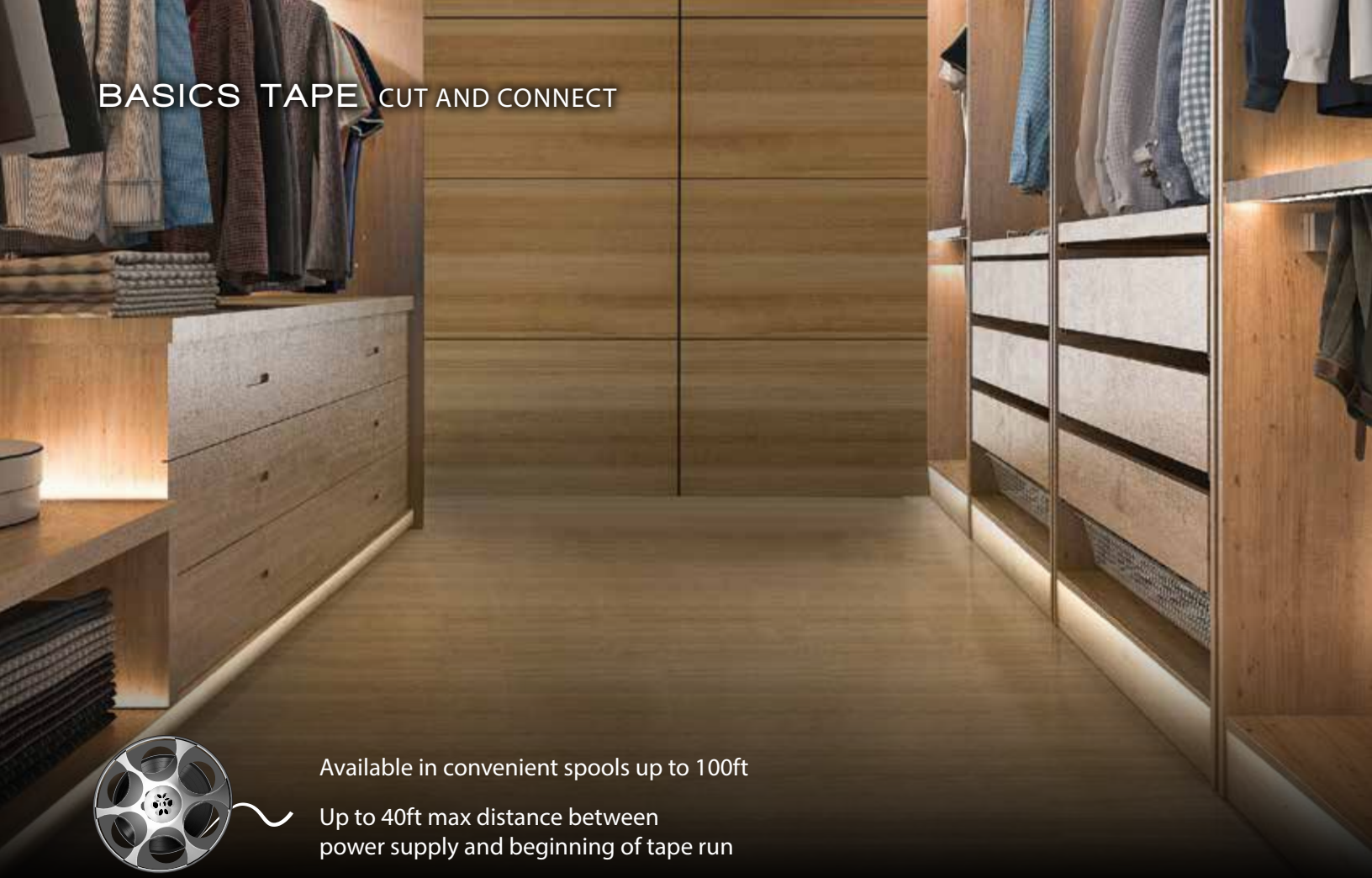

Available in convenient spools up to 100ft
Up to 40ft max distance between power supply and beginning of tape run

Cut and securely reconnect with ease



Input: 24VDC
Lumens: Up to 200 lm/ft
Rated Life: 50,000 hours
CRI: 90

- Cut and re-connectable with secure screw terminals accessories
- May be cut every 4 inches
- Good color rendering
- Suitable for installation in a clothes closet
- 40ft max distance between the power supply and beginning of tape

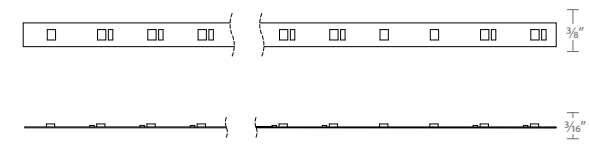

TAPE SELECTIONS

System	Lumens	Max Run	Power	Length	Color Temp	Finish
T24-BS1	100+lm/ft	40ft	1.2W/ft	15	2700K	WT White
				40	3000K	
				100	3500K	
T24-BS2	200+lm/ft	30ft	2.4W/ft	40	4000K	WT White
				100	5000K	

Example: T24-BS1-15-27WT

COMPATIBLE CLASS 2 POWER SUPPLY (REQUIRED)



- ELV Dimming 100%-10%
- 6ft Output lead wires



- Universal Input, ≥ 0.9 pf
- Overload and short circuit protection

Model	Dimension	Input	Output	Dimming
EN-BT60-24	6½" x 2¼" x 1¼"	120V	24VDC 60W	ELV
EN-BT96-24	6½" x 2¼" x 1¼"	120V	24VDC 96W	ELV

PS-24DC-U60R-BT	7¾" x 3¾" x 1"	120V-277V	24VDC 60W	ELV/TRIAC
PS-24DC-U96R-BT	8¾" x 3¾" x 1½"	120V-277V	24VDC 96W	ELV/TRIAC

ACCESSORIES

Connectors	Type	Model	Finish
	Inline Tape to Tape Connector Connects tape sections (10 pieces per pack)	T24-BS-MM	CL Clear
	Power to Tape Connector Connects tape sections (10 pieces per pack)	T24-BS-PM	CL Clear
	L Connector Connects tape sections (2 pieces per pack)	T24-BS-L	CL Clear
	Flex Y Connector Connects tape sections and power feed Includes LED-T-B (1pc)	T24-BS-Y	BK WT Black White
	Flex X Connector Connects tape sections and power feed Includes LED-T-B (1pc)	T24-BS-X	BK WT Black White
	Low Voltage Wiring Box Neatly house connections for up to 2 wires	LED-T-B	-- --

Example: T24-BS-MM-CL

Extension Cables	Type	Model	Finish
	Joiner Cable Extends distance between tape sections	T24-BS-IC-002 T24-BS-IC-006 T24-BS-IC-012 T24-BS-IC-036 T24-BS-IC-072	2 in 6 in 1 ft 3 ft 6 ft BK WT Black White
	Extension Cable Extends distance between tape sections and power supply (Includes LED-T-B (1 pc) & screw driver)	T24-BS-EX2-072 T24-BS-EX2-144 T24-BS-EX2-240 T24-BS-EX2-480	6 ft 12 ft 20 ft 40 ft BK WT Black White

Example: T24-BS-EX2-240-WT

PUCK LIGHT UNDERCABINET LIGHTING



Surface or Recessed Mounted

120V Direct Input
No Driver Required

BUILD A SYSTEM

Available in multiple color temperatures, finishes, and recessed or surface mounted options. Order single pucks or kits of multiple pucks to link together.

BEAUTIFULLY FINISHED CAST ALUMINUM



Black Brushed Nickel White

ALL-IN-ONE CCT SELECTABLE

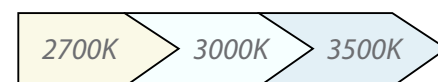

PUCK LIGHT UNDERCABINET LIGHTING



A solid lighting solution for kitchen counters, our 120V Undercabinet Puck Light with 3 CCT selectable technology provides quality illumination for all tasks.

Input: 120V
CRI: 90+
Dimming: 100%-10% ELV
100%-5% TRIAC
Rated Life: 50,000 hours

- CCT Selectable: 2700K/3000K/3500K
- Available for surface or recessed mount
- **No driver required**
- Construction: Die-cast Aluminum and PC Diffuser

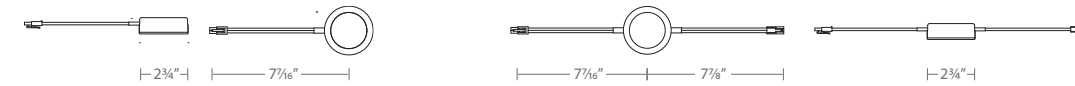

NEW	Image	Model	Power	Max Lumens	Color Temp			Finish	
					CS	2700K 3000K 3500K	BK BN WT	Black Brushed Nickel White	
		HR-AC70 1 single wired light	4.0W	290	CS	2700K 3000K 3500K	BK BN WT	Black Brushed Nickel White	
		HR-AC71 1 single wired light and cord	4.0W	290	CS	2700K 3000K 3500K	BK BN WT	Black Brushed Nickel White	
		HR-AC72 1 double wired light	4.0W	290	CS	2700K 3000K 3500K	BK BN WT	Black Brushed Nickel White	
		HR-AC73 Puck Light Kit: 2 double wired light, 1 single wired light, and cord	4.0W x 3	290 x 3	CS	2700K 3000K 3500K	BK BN WT	Black Brushed Nickel White	

Example: **HR-AC72-CS-BN**

Image	Model	Description			Finish	
		Power	Length	Linking Cable	BK WT	Black White
	HR-PC6				BK WT	Black White
	HR-HWB				BK WT	Black White
	HR-IC	12 24 36	12" 24" 36"	Linking Cable	BK WT	Black White

Example: **HR-HWB-BK**

TITLE 24
CALIFORNIA



50% OFF 100%



ROCKER SWITCH
ADJUSTS BETWEEN
0%, 50%, OR 100%

2700K 3000K 3500K

Perfect for lighting kitchen counters, our 120V Undercabinet Barlight with selectable 3 CCT technology and a High-Low switch to provide quality illumination for all tasks.

ALL-IN-ONE CCT SELECTABLE



Input: 120V
 Rated Life: 50,000 hours
 Dimming: 100%-10% ELV
 100%-5% TRIAC
 CRI: 90

- CCT Selectable: 2700K/3000K/3500K
- Rocker switch to adjust between 0%, 50%, or 100%
- Construction: Aluminum with white PC diffuser

Model	Length	Power	Max Lumens @3000K	Color Temp	Finish
BA-AC	08	8"	6.5W	CS 2700K 3000K 3500K	WT White
	18	18"	10.5W		
	24	24"	15W		
	30	30"	17.5W		

Example: **BA-AC18-CS-WT**

BLAZE 6" LED RECESSED



ALL-IN-ONE CCT SELECTABLE



BLAZE 6" Round and Square.
5-CCT selectable downlight.



Power: 25W
Input: 120-277V
Dimming: 100% - 10% ELV,
100%-5% TRIAC
Rated Life: 50,000 hours
CRI: 90

- Height: fixture 5 3/8"
- CCT Selectable: 2700K/3000K/3500K/4000K/5000K
- Installs into ceilings between 1/2" and 1 1/2" thick
- Remodel and New Construction applications
- Construction: Die-cast aluminum with frosted TIR lens
- Remote driver and wiring box included
- IC-Rated, Airtight and Wet Location Listed

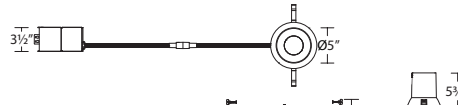
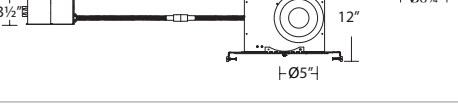
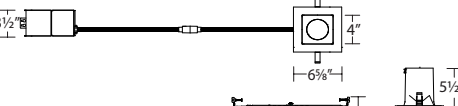
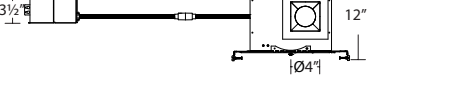

Model	Beam	Max Lumens	Max CBCP	Color Temp	Finish			
R6DRDR Round Remodel 	F	55°	2485	2292	9CS	2700K	WT	White
						3000K		
R6DRDN Round New Construction 	F	55°	2485	2292	9CS	3500K	WT	White
						4000K		
						5000K		
R6DSDR Square Remodel 	F	55°	2360	2340	9CS	2700K	WT	White
						3000K		
R6DSDN Square New Construction 	F	55°	2360	2340	9CS	3500K	WT	White
						4000K		
						5000K		

Example: **R6DSDR-F9CS-WT**

Frame-In Kit (Optional Accessory)	Model	Notes
New Construction 	R6DRDN-FRAME IC-Rated, Airtight	Ceiling thickness: 1/2"-1 1/2"

ION 2" LED RECESSED





Minimum profile ION 2" Round and Square downlight with remote driver and electrical connection box for easy remodel or new construction installation.



Power: 9W
Input: 120-277V
Dimming: 100% - 10% ELV,
100%-5% TRIAC
Rated Life: 50,000 hours
CRI: 90

- Height: Fixture 3 7/8"
- Installs into ceilings between 1/2" and 1 1/2" thick
- Construction: Die-cast aluminum with frosted TIR lens
- IC-Rated, Airtight and Wet Location Listed

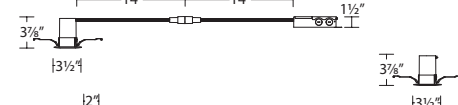
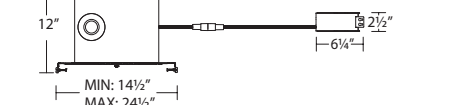
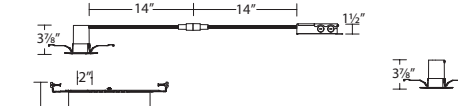

Model	Beam	Max Lumens	Max CBCP	Color Temp	Finish				
R2DRDR Round Remodel 	F	45°	710	993	930	3000K	WT	White	
									3000K
R2DRDN Round New Construction 	F	45°	710	993	930	3000K	WT	White	
									4000K
									5000K
R2DSDR Square Remodel 	F	45°	755	1014	930	3000K	WT	White	
									3000K
R2DSDN Square New Construction 	F	45°	755	1014	930	3000K	WT	White	
									4000K
									5000K

Example: **R2DRDR-F930-WT**

Frame-In Kit (Optional Accessory)	Model	Notes
New Construction Frame 	R2DRDN-FRAME IC-Rated, Airtight	Ceiling thickness: 1/2" - 1 1/2"



LOTOS 4" & 6" LED RECESSED



ALL-IN-ONE CCT SELECTABLE



Shallow profile LED that is designed to fit in furred down ceilings without sacrificing lumen output.

Input: 120-277V
Rated Life: 50,000 hours
Dimming: 100%-10% ELV, 100%-5% TRIAC
CRI: 90

- Height: Fixture-1", Driver 1 1/4"
- Heavy gauge retention clips secures fixture to ceiling
- Installs into ceilings between 1/2" and 1 1/2" thick
- Construction: Steel with translucent diffuser
- 5 Year Warranty
- CCT Selectable: 2700K/3000K/3500K/4000K/5000K

Model	Beam	Power	Max Lumens	Color Temp		Finish	
				9CS	WT	WT	White
R4ERDR 4" Round Downlight IC-Rated, Airtight	W	8W	725	2700K	WT	White	
				3000K			
				3500K			
				4000K			
				5000K			
R6ERDR 6" Round Downlight IC-Rated, Airtight	W	14W	1200	2700K	WT	White	
				3000K			
				3500K			
				4000K			
				5000K			

Example: **R4ERDR-W930-WT**

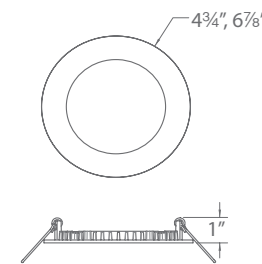

LOTOS 2" ADJUSTABLE LED RECESSED



Shallow profile LED that is designed to fit in furred down ceilings without sacrificing light output.

- Input:** 120-277V
- Rated Life:** 50,000 hours
- Dimming:** 100%-10% ELV, 100%-5% TRIAC
- CRI:** 90
- Height: fixture-1 1/8", Driver 1 1/4"
- 360° Retractable Pivot: Downlight and Adjustable
- Heavy gauge retention clips secures fixture to ceiling
- Installs into ceilings between 1/2" and 1 1/2" thick
- Construction: Steel with frosted TIR lens

Model	Beam	Power	Max Lumens	Max CBCP	Color Temp	Finish
R2ERAR 2" Round Adjustable IC-Rated, Airtight	W 35°	6W	500	1203	930 3000K	WT White
R2ESAR 2" Square Adjustable IC-Rated, Airtight	W 35°	6W	500	1203	930 3000K	WT White

Example: **R2ERAR-W930-WT**

LOTOS 2" ADJUSTABLE LED MULTIPLES



Shallow profile LED that is designed to fit in furred down ceilings without sacrificing light output.

- Input:** 120-277V
- Rated Life:** 50,000 hours
- Dimming:** 100%-10% ELV, 100%-5% TRIAC
- CRI:** 90
- Height: fixture-1 1/8", Driver 1 1/4"
- 360° Retractable Pivot: Downlight and Adjustable
- Heavy gauge retention clips secures fixture to ceiling
- Installs into ceilings between 1/2" and 1 1/2" thick
- Construction: Steel with frosted TIR lens

Model	Beam	Power	Max Lumens	Max CBCP	Color Temp	Finish
R2ESAR-2 2 Light Adjustable IC-Rated, Airtight	W 35°	12W	500x 2	1203 x2	930 3000K	WT White
R2ESAR-3 3 Light Adjustable IC-Rated, Airtight	W 35°	18W	500x3	1203 x3	930 3000K	WT White

Example: **R2ERAR-2-W930-WT**

LOTOS 4" & 6" ADJUSTABLE LED RECESSED



ALL-IN-ONE CCT SELECTABLE



Shallow profile LED that is designed to fit in furred down ceilings without sacrificing lumen output.

- Input:** 120-277V
- Rated Life:** 50,000 hours
- Dimming:** 100%-10% ELV, 100%-5% TRIAC
- CRI:** 90
- Height: fixture-1½", Driver 1¼"
- 360° Retractable Pivot: Downlight and Adjustable
- Heavy gauge retention clips secures fixture to ceiling
- Installs into ceilings between ½" and 1½" thick
- Construction: Steel with frosted TIR lens
- CCT Selectable: 2700K/3000K/3500K/4000K/5000K

	Model	Beam	Power	Max Lumens	Max CBCP	Color Temp	Finish
	R4ERAR 4" Round Adjustable IC-Rated, Airtight	W 45°	9W	795	1050	930 3000K	WT White
						9CS 3500K 4000K 5000K	
	R4ESAR 4" Square Adjustable IC-Rated, Airtight	W 45°	9W	795	1050	930 3000K	WT White
	R6ERAR 6" Round Adjustable IC-Rated, Airtight	W 45°	15W	1340	1915	930 3000K	WT White
						9CS 2700K 3000K 3500K 4000K 5000K	

Example: **R4ERAR-W930-WT**

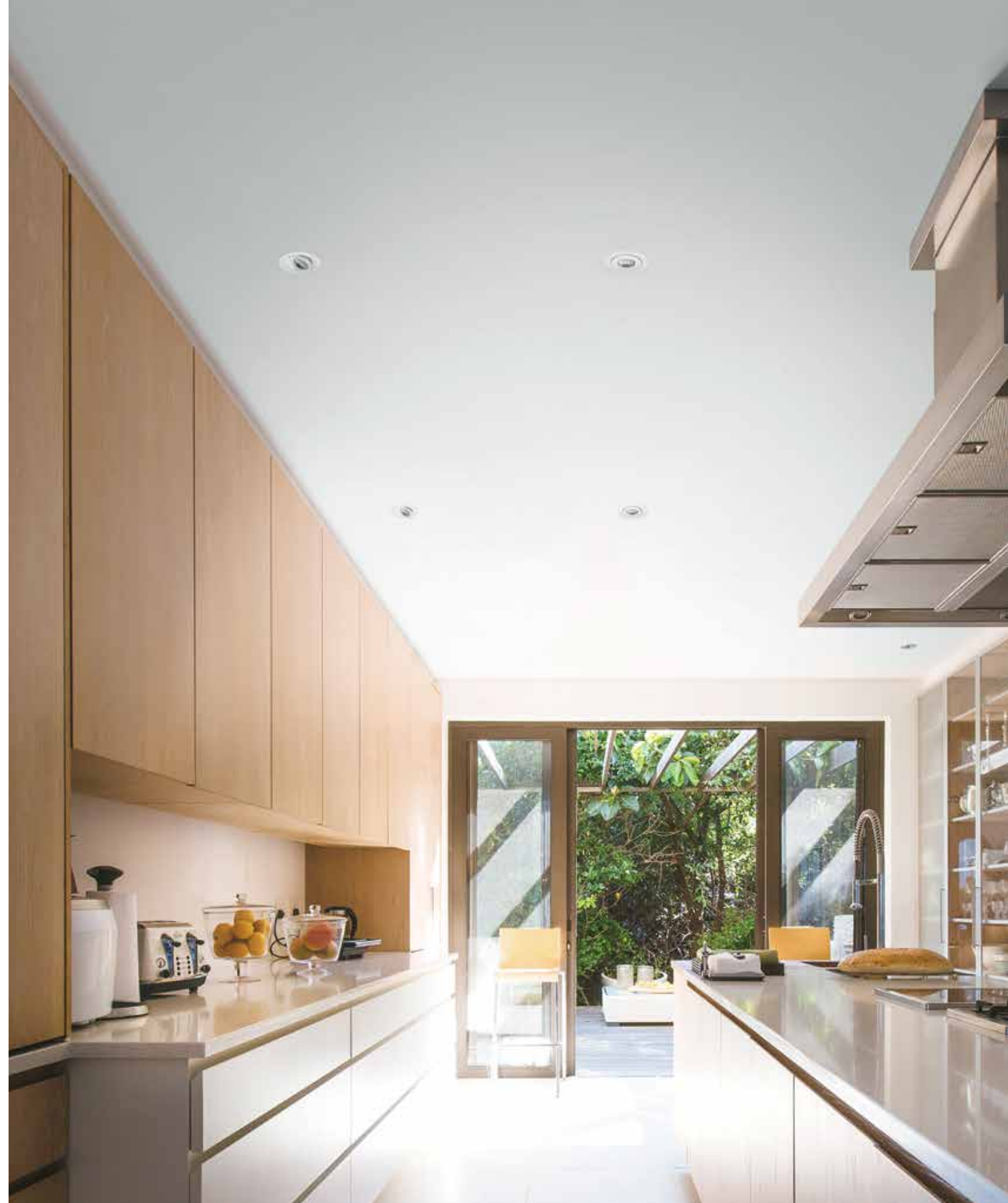

CHARGE 8010 LED TRACK
NEW BRUSHED NICKEL AND DARK BRONZE FINISHES



CHARGE 8020 LED TRACK



The Charge track luminaire offers superior light output in a small, unobtrusive design. Developed for residential spaces and lower-mounted commercial applications.

Power: 11W
Delivered Lumens: Up to 850
CBCP: Up to 1196
Comparable to: 65W MR16
Dimming: 100%-10% ELV, 100%-5% TRIAC
Input: 120V
Rated Life: 50,000 hours

- Suitable for H, J or L track
- Also available as a 4ft track pack kit
- 350° horizontal and 90° vertical aiming
- Construction: Die-cast aluminum with frosted TIR lens
- 5 Year Warranty

	System	Model	Beam	Lumens	CBCP	Color Temp	CRI	Finish
	H H Track	8010	45°	850	1196	30 3000K	90	BK Black BN Brushed Nickel DB Dark Bronze WT White
	L L Track J J/J2 Track	8010	45°	850	1196	30 3000K	90	BK Black WT White
	H H Track	8010/3	45°	850 x3	1196 x3	30 3000K	90	BK Black BN Brushed Nickel DB Dark Bronze WT White

Track Pack includes
• 4ft H Track
• Floating Canopy
• Three 8010 Charge Track Heads

Example: **H-8010-30-DB**

Power: 16W
Delivered Lumens: Up to 1280
CBCP: Up to 1402
Comparable to: 65W MR16
Dimming: 100%-10% ELV, 100%-5% TRIAC
Input: 120V
Rated Life: 50,000 hours

- Suitable for H, J or L track
- 350° horizontal and 90° vertical aiming
- Driver concealed within fixture
- Construction: Die-cast aluminum with frosted TIR lens
- 5 Year Warranty

	System	Model	Beam	Lumens	CBCP	Color Temp	CRI	Finish
	H H Track L L Track J J/J2 Track	8020	45°	1280	1402	30 3000K	90	BK Black BN Brushed Nickel DB Dark Bronze WT White

Example: **H-8020-30-WT**

SOLO LED FIXED RAIL
NEW BLACK AND WHITE FINISHES

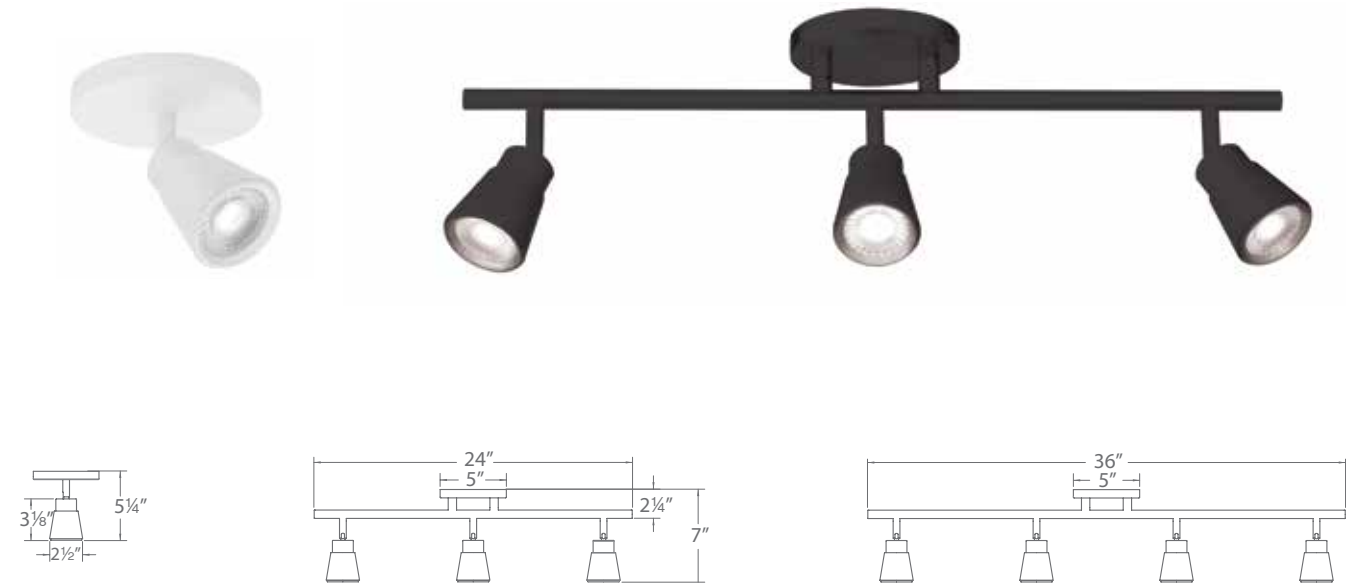

Monopoint, 3-head, or 4-head fixed track with individually adjustable LED track fixtures can be wall mounted or ceiling mounted for a wide multitude of applications. It is specifically designed for residential and low-ceiling commercial applications.

Power: 10W/head
Delivered Lumens: Up to 800
CBCP: Up to 1095
Comparable to: 65W MR16
Dimming: 100%-10% ELV, 100%-5% TRIAC
Input: 120V
Rated Life: 50,000 hours

- Monopoint, 3-head, or 4-head fixed rails
- Sizes: 5" (Monopoint), 24", 36"
- Construction: Die-cast aluminum with frosted TIR lens
- Installation: Wall and Ceiling
- 350° horizontal and 90° vertical aiming per head
- 5 Year Warranty

System	Model	Lights	Beam	Lumens	CBCP	Color Temp	CRI	Finish
TK	1805	01 03 04	45°	800/head	1095/head	30 3000K	90	BK BN WT Black Brushed Nickel White

Example: **TK-180503-30-BK**

LITHIUM EM BATTERY BACKUP



ALL-IN-ONE CCT SELECTABLE



Convenient emergency battery backup button is discreet to maintain product appearance

The standard ceiling light and emergency battery backup ceiling light are nearly identical in 2 convenient sizes.

High light-output, hidden hardware, and broad, even illumination are the primary features of this sleek flush mount. Often used in hallways, dorm rooms, and bathrooms, installation is a snap.

Input: 120-277V
CRI: 90
Dimming: 100%-10% ELV, 100%-5% TRIAC
Rated Life: 50,000 hours

- CCT Selectable: 2700K/3000K/3500K/4000K/5000K
- Install over 3", 4" or a combination 3/0-4/0 electrical box
- Construction: Aluminum with translucent diffuser

	Model	Wattage	Max Lumen	Color Temp	CRI	Finish
	FM-200111	15W	1080	CS 2700K 3000K 3500K 4000K 5000K	90	BN Brushed Nickel
	FM-200115 FM-200115EM Emergency Back Up	25W	1815			
	FM-200118 FM-200118EM Emergency Back Up	31W	2410			

Example: **FM-200115-CS-BN**



GLO · BLO · FLO

LED FUNCTIONAL CEILING AND WALL MOUNTS



ALL-IN-ONE CCT SELECTABLE



GLO

- Install over 3", 4" or a combination 3/0-4/0 electrical box
- Construction: Aluminum with translucent diffuser
- 5 Year Warranty
- CCT Selectable: 2700K/3000K/3500K/4000K/5000K



	Model	Max Lumens	Power	Color Temp	CRI	Finish
	FM-211	1210	15W	CS 2700K 3000K 3500K 4000K 5000K	90	WT White
	FM-214	1740	22W	CS 2700K 3000K 3500K 4000K 5000K	90	
	FM-216	2180	26W	CS 2700K 3000K 3500K 4000K 5000K	90	

Example: **FM-214-CS-WT**

BLO

- Install over 3", 4" or a combination 3/0-4/0 electrical box
- Construction: Aluminum with translucent diffuser
- 5 Year Warranty
- CCT Selectable: 2700K/3000K/3500K/4000K/5000K



	Model	Max Lumens	Power	Color Temp	CRI	Finish
	FM-113	1650	22W	CS 2700K 3000K 3500K 4000K 5000K	90	WT White
	FM-115	2115	26W	CS 2700K 3000K 3500K 4000K 5000K	90	

Example: **FM-115-CS-WT**

FLO

- Sizes: 24", 36", 48"
- Construction: Aluminum with white acrylic diffuser
- Installation: Wall and Ceiling
- 5 Year Warranty
- CCT Selectable: 2700K/3000K/3500K/4000K/5000K



	Model	Max Lumens	Power	Color Temp	CRI	Finish
	WS-224	1460	17W	CS 2700K 3000K 3500K 4000K 5000K	90	WT White
	WS-236	2400	28W	CS 2700K 3000K 3500K 4000K 5000K	90	
	WS-248	2895	32W	CS 2700K 3000K 3500K 4000K 5000K	90	

Example: **WS-23662-CS-WT-23**

CYLINDER OUTDOOR SCONCE



Available in single and double directions, Cylinder is ideal for illuminating outdoor entrances and walkways.

Input: 120V
CRI: 80
Dimming: 100%-10% ELV
Rated Life: 50,000 hours

- Construction: Die-cast aluminum
- Sizes: 6 3/4" Single Light, 9 1/8" Double Lights
- Finish: Powder Coated Aluminum

	Model	Watt	Max Delivered Lumens	Color Temp	CRI	Finish	
	WS-W190208	6W	260	30	3000K	80	BK Black BZ Bronze WT White
	WS-W190212	18W	515				

Example: **WS-W190208-30-BZ**

VEGA OUTDOOR SCONCE



Input: 120V
CRI: 90
Dimming: 100%-10% ELV
Rated Life: 50,000 hours

- Construction: Die-cast Aluminum with acrylic diffuser
- Sizes: 9" and 14"
- Finish: Powder Coated Aluminum

	Model	Watt	Max Delivered Lumens	Color Temp	CRI	Finish	
	WS-W190109	8W	545	30	3000K	90	BK Black
	WS-W190114	16W	1,050				

Example: **WS-W190114-30-BK**

DISC II LED FAN



F-033L-BN



An energy efficient LED luminaire with a quiet DC motor makes Disc 70% more efficient than AC fans.

DISC II LED FAN



A streamlined look suited for bedrooms and living rooms. The sweep of the 52" blades efficiently create a "cooling effect" and complement the silent DC motor.

- Blade: 13° Pitch, 52" Sweep, Plywood
- Downrod: 3/4" W x 4 1/2" H Included
- Mounting Slope: Up to 30°
- Lead Wire: 80"
- Hanging Weight: 18 lbs
- LED Lumens: 2100
- Total Power: 52W
- LED Power: 25W

- 3-speed 120 x 15 DC motor for quiet and powerful operation
- Precision balanced blades for wobble-free operation
- Pull-chain operated and reversible from housing
- Fan and LED module are Energy Star® certified
- Memory module—fan will recall last speed setting if switched off
- Damp rated

Model		Housing	Blade
F-033L	BN	Brushed Nickel	Titanium Silver
	MB	Matte Black	Matte Black
	MW	Matte White	Matte White

Example: F-033L-BN

ENERGY GUIDE		
Standard	High Speed	Weighted Average
Electricity	25W	17W
Airflow	5,032 CFM	3,964 CFM
Energy Costs*	-	\$5/yr
Efficiency	237 CFM/W	237 CFM/W

*Estimated annual energy cost based on \$0.12 per kWh and 6.4 hours use per day

ACCESSORIES sold separately		
DC-I Coupler	BN	Brushed Nickel
	MB	Matte Black
	MW	Matte White
SC- Slope Ceiling Kit	BN	Brushed Nickel
	MB	Matte Black
	MW	Matte White

ACCESSORIES sold separately			
DR- Downrods	12	48	BN Brushed Nickel
	18	60	MB Matte Black
	24	72	MW Matte White
	36		

INDEX

RECESSED

OCULARC 2" MULTIPLE SPOTS6
OCULARC 1.0	10
OCULARC 2.0	11
OCULARC 3.0, OCULARC 3.0 DIM-TO-WARM	12
OCULARC 3.5	14
OCULARC 3.5 DIM-TO-WARM	16

TRACK/MONOPOINT

PALOMA 502824
SILO LED PENDANT26

INVISILED®

INVISILED® CCT COLOR TEMPERATURE ADJUSTABLE TAPE28
INVISILED® OUTDOOR WET RATED LED TAPE34

PIXELS

PIXELS CCT36
------------------	-----

OUTDOOR

CUBE ARCHITECTURAL40
STEP LIGHTS WITH INTEGRAL PHOTOCELL42

LANDSCAPE

LINEAR PATH LIGHT46
GRAND WALL WASH48
ACCENT50
INTERBEAM ACCENT51
HARDSCAPE52
CANOPY54
SURFACE MOUNTED STEP LIGHT55

LIMITED

BASICS TAPE CUT AND CONNECT58
PUCK LIGHT60
BAR LIGHT62
BLAZE 6" LED RECESSED64
ION 2" LED RECESSED65
LOTOS ADJUSTABLE LED RECESSED66
CHARGE 801072
CHARGE 802073
SOLO74
LITHIUM75
GLO77
BLO77
FLO77
CYLINDER78
VEGA79
DISC II80

Headquarters

Tel: 800.526.2588
Fax: 800.526.2585

West Coast Factory

1750 S Archibald Ave
Ontario, CA 91761

East Coast Factory

44 Harbor Park Dr
Port Washington, NY 11050

Central Factory

1600 Distribution Ct
Lithia Springs, GA 30122

Consult the factory to take advantage of our custom capabilities in large quantities. For up to date product specifications and assistance please visit **waclighting.com** or call **1-800-526-2588**

