

WAC
STRUT



Industrial Chic, Warehouse District, Brooklyn. All very popular current design trends but they aren't conducive to traditional lighting fixture installations.

Imagine a system designed to change with the times. You could use all your familiar light sources in a system that was designed to adapt to the times.

Not everyone's workspace has the same lighting requirements.

Imagine if each person could customize the lighting in their area to maximize efficiency.

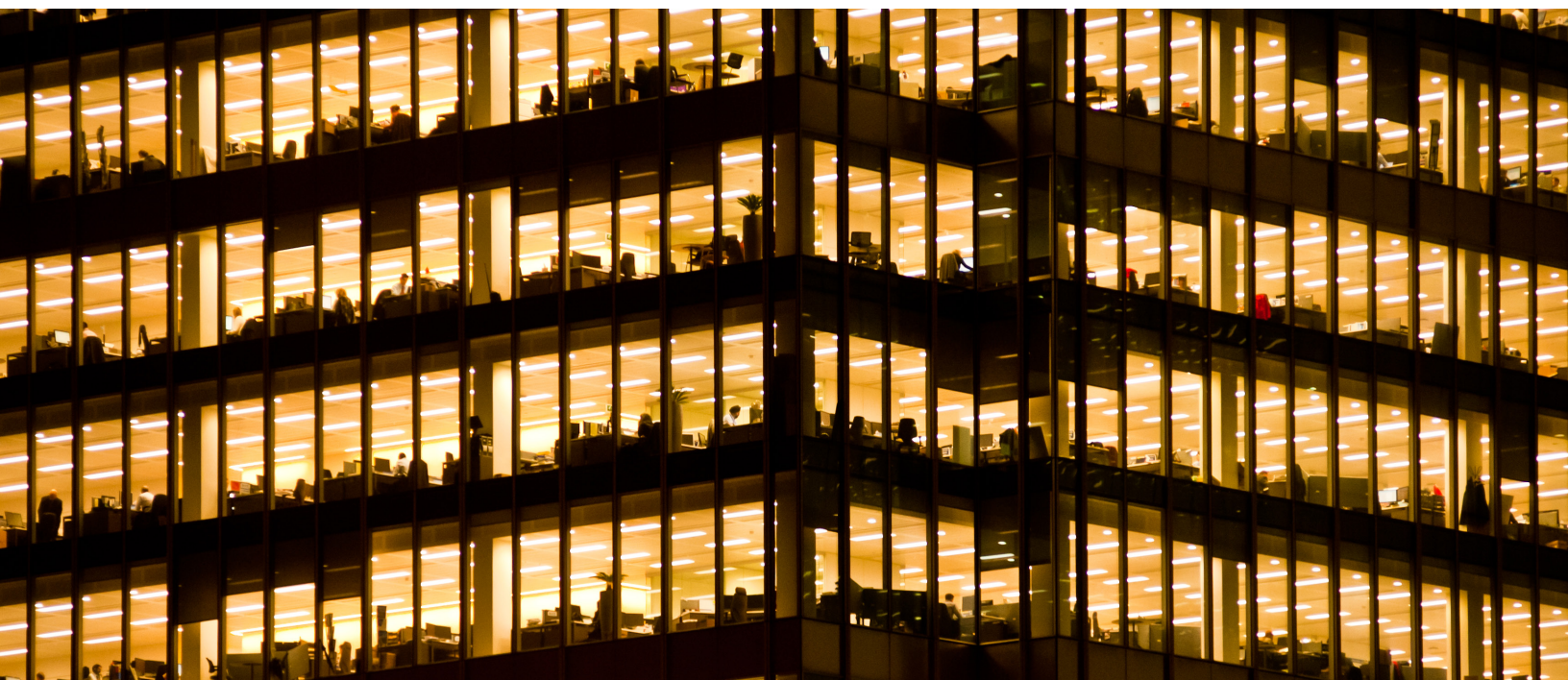



High-end retail looks more and more like a museum, needing higher quality lighting and various lighting types to fill in a design properly.

Imagine a system with a multitude of lighting types that you can change for your client whenever they move their retail displays.

Open layouts, clean high ceilings and large windows are a great way to bring in natural lighting in your space, until it starts to rain.

Imagine a system that adapts to your lighting needs and to provide comfortable illumination all day and night.





WAC STRUT

The only lighting, power, and control system complete with lighting elements designed for discriminating performance.

Configure STRUT for your retail, restaurant, commercial office, or residential lighting plan without custom lead times—get exactly what you want, when you want it.

HOT SLIDE

Magnetic infrastructure allows you to slide elements within the STRUT and adjust lighting effects while powered

STEALTH

Design details include precise form and finishes, like black copper busways for power and communications

MODULAR

Configure standard components for a customized solution

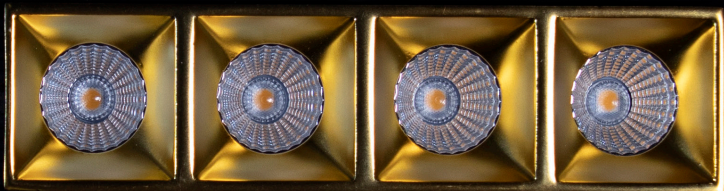

THE ONLY CONSTANT IS CHANGE.

– Heraclitus c. 504 BC

CHANGE YOUR MIND

Need to spotlight artwork there?
Or does the furniture plan change late
in the game? Avoid construction delays
and change orders with a modular power
system where lighting elements can
be modified on site with ease.



Change your mind after installation?

Place your luminaires in groups at any time without having to modify wiring. Lights are all uniquely addressable to be controlled individually or grouped as desired. All communications with the Connected Power Unit are wired for stability and security. Integration to your control system can also be hardwired.

WAC STRUT

CHANGE ON SITE

STRUT is fully customizable. Easy to specify and order without special knowledge, STRUT can adapt to changing design decisions with ease. Choose your components, all ready to ship within a week.

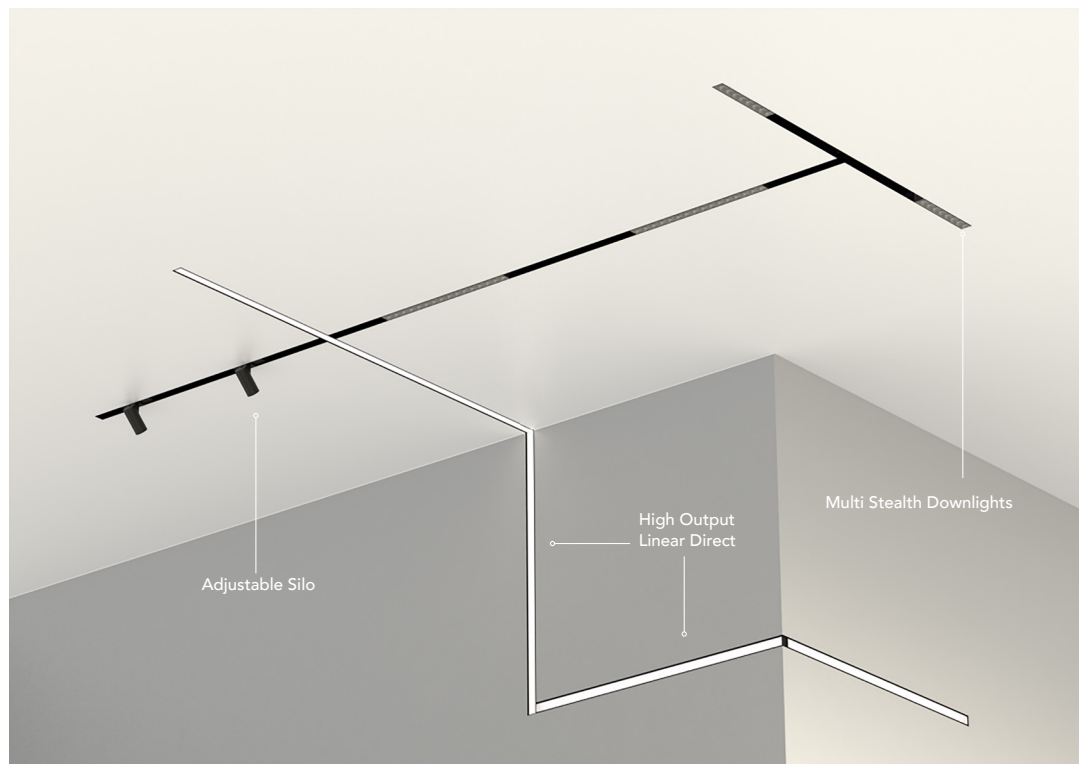

See Page 53

There is a light at the end of the corner. Use illuminated Inner Corner connectors where ceilings meet walls for a continuous line of light.



LIGHTING WITHOUT LIMITS

WAC
STRUT

CHANGE AS OFTEN AS YOU WISH

STRUT gives users the experience they've been looking for. Get setup and online, quickly and easily using the WAC app for iOS or Android. Gain individual control for luminaire elements.

Basic functions, like On/Off/Dim, Grouping and Scheduling can be performed by anyone with a simple user interface.

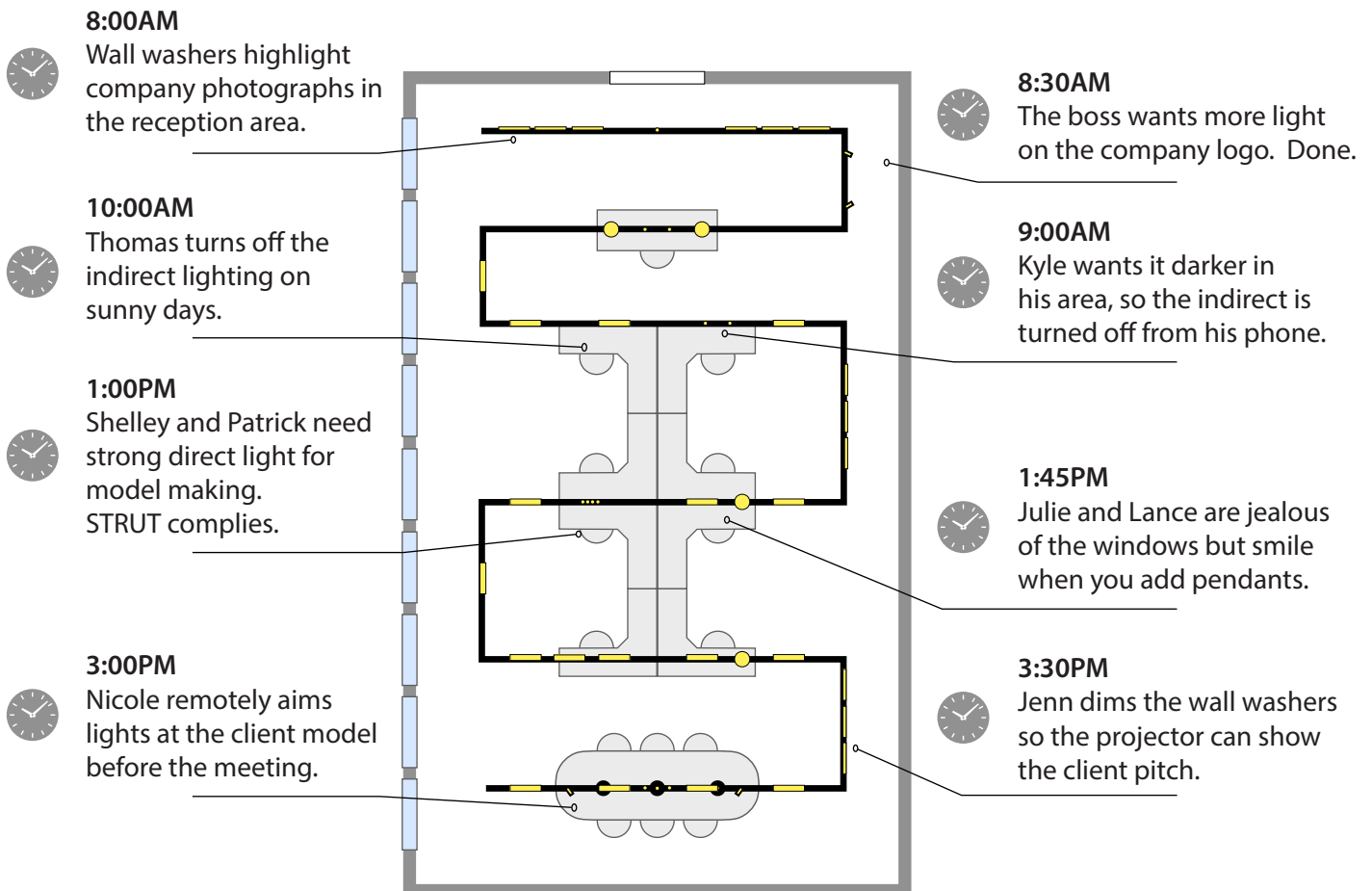

CHANGE OF CONTROL

STRUT is technology agnostic. Interfaces are available with TRIAC, ELV, 0-10V, or DMX protocols. Commission through our wireless app. Then integrate with a variety of control systems. Confidently specify knowing that STRUT is designed for seamless integration with the control systems clients are already using.

Changes to fixture grouping or actions are automatically recognized by control systems that are integrated with the Connected Power Unit.

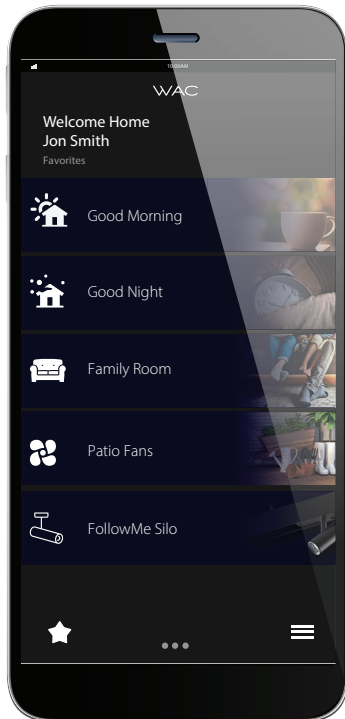

INDIVIDUAL CONTROL

Operate each fixture independently, or create groups for circuit-simulating control. User presets can allow you to change your entire lighting scheme on the fly.

SCHEDULE

Create schedules – keep it simple with a 7-day weekly calendar, or get as granular as you want with a 365-day calendar that automatically accounts for daylight savings time changes.

COMMISSION

Commission your lighting array with our exclusive, free WAC app. Then control it from anywhere in the world.

INTEGRATION

Integrate with popular control systems through standard hardware for basic On/Off/Dim functions. Higher level integrations will be made available as these systems update. New functions will be made available through future over-the-air updates.

CHANGE ON A MOMENT'S NOTICE

Change the brightness, beam angle,
and aiming direction remotely.

Our patent-pending smart system takes
the concept of a motorized track head and
integrates it into everyday activity without
requiring more thought from the user.

WAC
STRUT



CHANGE WITH SEASONS

Or as often as you'd like. Direct and adjust
beam spread to highlight frequently moved
objects, like seasonal retail displays and tables
in a convention center.

CHANGE AS OFTEN AS THE WEATHER

Install the combination Vacancy/Photo sensor anywhere on the STRUT system to monitor any area you desire. Using our WAC app, configure STRUT to automatically adjust lighting based on occupancy of a space, or in Daylight Harvesting Mode to adjust STRUT elements to achieve balanced lighting.

BRIGHTNESS



AS A TRUE MANUFACTURER

We're able to take a totally modular system to the next level.



For longer suspension lengths to STRUT or STRUT elements – make it CUSTOM

For a pop of color outside of our standard offering – reach out with a RAL code and make it CUSTOM

For special intermediate lengths that offer electrical and data connectivity, delivered quickly, make it CUSTOM.

Need specialized optics, color rendering, lumen outputs or a whole new element? Send us your dream and let's make it CUSTOM!

If you don't see what you're looking for, ask us about our CUSTOM capabilities!
Contact us at customs@wacighting.com.

SUBMITTALS

The STRUT system balances advanced flexibility with ease of use to make specification and installation a breeze. But a second pair of eyes never hurts!

Our Submittals team offers world-class service to provide:

Detailed Bill of Materials

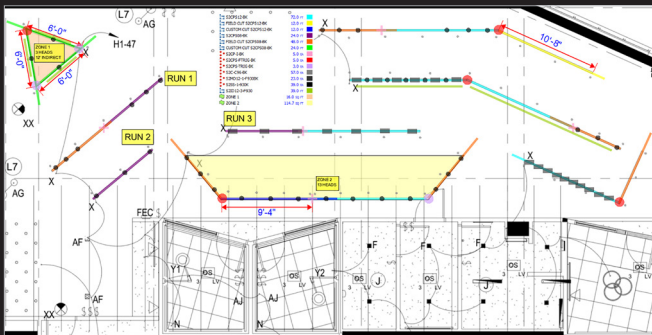

Layouts



Shop Drawings for Installation Detail

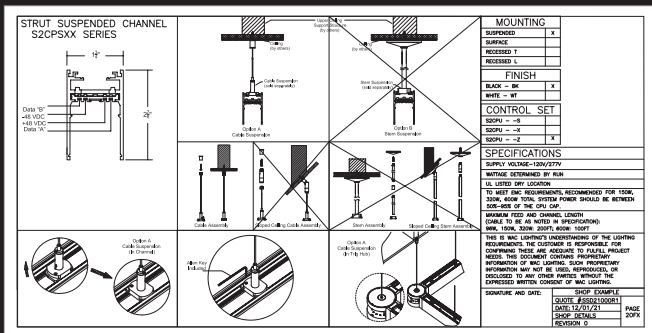

Dimming Wiring Diagrams

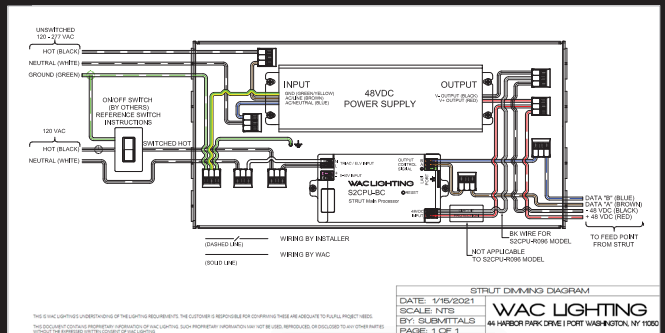

Contact us at submittals@wacighting.com for product layouts and solutions.

YOUR ARSENAL

Engineered to North American building and electrical standards, WAC STRUT supports all of the following UL/cUL dry location listed, and Title 24 compliant lighting elements you see here.

This is a complete program with Direct, Indirect, Wall Wash, Downlights, Spotlights, and Pendants.

Components and Accessories starting at p.46

DIRECT

A line of light with 3 lumen packages, 4 CCTs, and a flush or regressed option for superior glare control.

p.18-19



INDIRECT

A high output or diffused option for indirect reflected illumination.

p.20-21

STEALTH WALL WASH

Discriminating Wall Wash performance from a sleek package that hides within.

p.22-23



MULTI STEALTH DOWNLIGHTS

Micro size. Low glare reflectors in multiple finishes. Available in 4, 8, and 16 light elements.

p.24-25



STEALTH DOWNLIGHT

The cornerstone of your system. A patent-pending low glare reflector design. Choose from multiple finishes.

p.26-27



STEALTH SILO

A patent-pending adjustable beam accent light or downlight - change your mind on the fly.

p.28-29



SILO

Superior light output and beam adjustability in a small, unobtrusive design.

p.30-31



FOLLOWME SILO

Finally, a patent-pending motorized accent light that thinks and communicates.

p.32-33



SILO PENDANT

Our patent-pending Silo pendant with STRUT for ultimate adjustability.

p.34-35



NIVEOUS

Playful glass orbs in 4 CCTs and 3 hardware finishes.

p.36-37



ELEMENTUM

Opal glass cylinders in 4 CCTs and 3 hardware finishes.

p.38-39



FLARE

Durable aluminum housing and acrylic diffuser provide 360° of even illumination.

p.40-41



VOLO

Volo balances form and function, used individually or in groups.

p.42-43



RECESSED CHANNEL

Use recessed channels to flush with your ceilings and walls, and take advantage of the many discreet elements STRUT has to offer. Mounting hardware is also available, including suspensions that support your system from above the ceiling line.

SUSPENDED CHANNEL

For high ceiling applications, we offer suspended channels with low profile aircraft cables or stem supports. All channels may be field cut.





For the utmost architectural fit and finish, choose recessed trimless channels that install cleanly for that perfect, seamless look.

RECESSED TRIMLESS CHANNEL

Surface mount for lower ceilings. A remote or surface mounted CPU is available to run power. Channel covers in black and white may also be field cut to hide gaps between elements.

SURFACE MOUNTED CHANNEL



HIGH OUTPUT & REGRESSED DIRECT ELEMENTS

A line of light.

STRUT gives you many options for direct lighting. Flush mount will provide high lumen output and a clean line of light. Regressed elements reduce glare with a deep cutoff. Three power level options available to accommodate power and lighting appropriately to applications.

Power:	Up to 53W
Lumens:	Up to 925 lm/ft
Comparable to:	T5HO (using elements at Power Level 3)
Dimming:	100% - 0.1%
Input:	48V DC
Rated Life:	50,000 hours



Direct Regressed Element

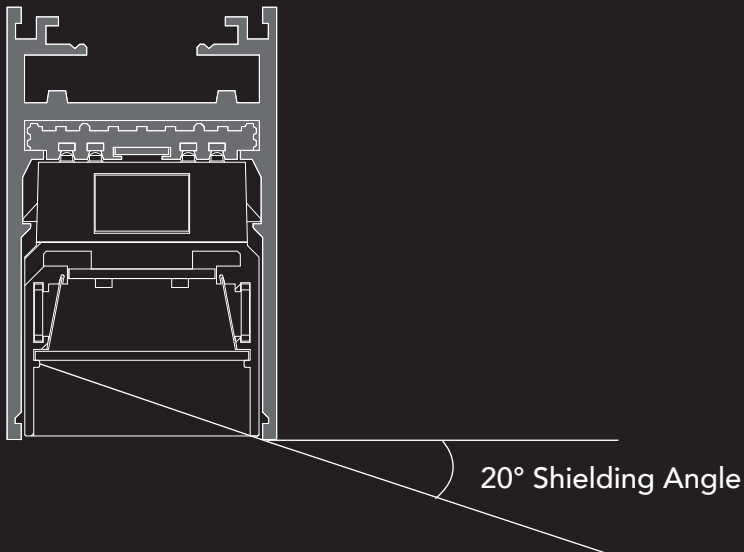

DIRECT LINE OF SIGHT

A line of light with a flush to channel lens or with a 1/2 inch regressed lens for superior glare control.

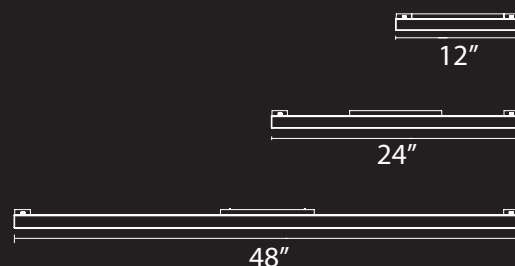

HIGH OUTPUT DIRECT

System	Model	Length	Power	Max Lumens	Color Temp	CRI	Finish							
S2	DH Direct Flush Lens	12	12" 1	7W	470	F927 2700K F930 3000K F935 3500K F940 4000K	90	BK Black						
			2	10W	670									
			3	14.5W	910									
		24	24" 1	12.5W	970				F927 2700K F930 3000K F935 3500K F940 4000K	90	BK Black			
			2	18.5W	1,370									
			3	27W	1,850									
		48	48" 1	24.5W	1,940							F927 2700K F930 3000K F935 3500K F940 4000K	90	BK Black
			2	37W	2,740									
			3	53W	3,690									

Example: **S2DH12-1-F930BK**

REGRESSED DIRECT

System	Model	Length	Power	Max Lumens	Color Temp	CRI	Finish							
S2	DR Direct Regressed Lens	12	12" 1	7W	350	F927 2700K F930 3000K F935 3500K F940 4000K	90	BK Black						
			2	10W	500									
			3	14.5W	690									
		24	24" 1	12.5W	740				F927 2700K F930 3000K F935 3500K F940 4000K	90	BK Black			
			2	18.5W	1,050									
			3	27W	1,410									
		48	48" 1	24.5W	1,470							F927 2700K F930 3000K F935 3500K F940 4000K	90	BK Black
			2	37W	2,090									
			3	53W	2,810									

Example: **S2DR24-1-F930BK**

HIGH OUTPUT & DIFFUSED INDIRECT ELEMENTS

Add another dimension of light.

Indirect lighting can be built into STRUT right in the field. Channels can be field cut and equipped with accessories such as clear, diffused and batwing lenses. Three power level options available to accommodate power and lighting appropriately to applications.

Power:	Up to 48W
Lumens:	Up to 910 lm/ft
Comparable to:	T5HO (using elements at Power Level 3)
Dimming:	100% - 0.1%
Input:	48V DC
Rated Life:	50,000 hours



TITLE 24
CALIFORNIA



KEEP IT CLEAN

Optional diffusers minimize glare, widen distribution, and avoid collecting dust on hardware. Perfect for a multistory office or healthcare environment.

THE PERFECT AMBIANCE

Choose indirect lighting for comfortable, reflected illumination. Optional dust cover and lens can be installed where desired.

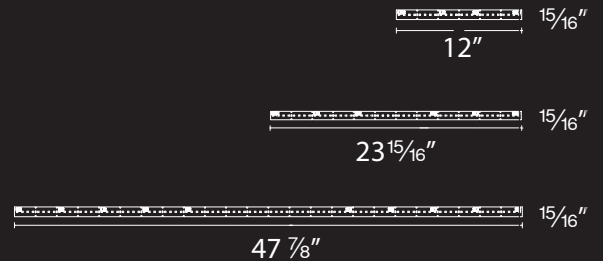

INDIRECT

System	Model	Length		Power		Max Lumens	Color Temp	CRI
S2	ID Indirect	12	12"	1	6W	460	F927 2700K F930 3000K F935 3500K F940 4000K	90
				2	9W	680		
				3	12W	910		
		24	24"	1	12W	910		
				2	18W	1,360		
				3	24W	1,820		
		48	48"	1	24W	1,820		
				2	36W	2,730		
				3	48W	3,650		

Example: **S2ID48-3-F930**

DRIVER (Required per run of Indirect Elements up to 96W max)

Installs in top side of channel to power and provides individual addressability to Indirect Elements.

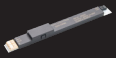
System	Model	Length		Max Power	Total Length Per Power Supply
 S2	ID Indirect	DR	Driver	96	96W 16 ft (6W/ft) 10 ft (9W/ft) 8 ft (12W/ft)

Example: **S2ID-DR96**

LENS ACCESSORIES

System	Model	Length		Type	
LENS-S2	ID Indirect	96	96"	CL	Clear Lens
				FR	Diffuse Lens
				BW	Batwing Lens

Example: **LENS-S2ID96-CL**

STEALTH WALL WASH

WASH ELEMENTS

Spatial illumination.

Mounted to a perpendicular surface, our wall wash elements eliminate contrast and provide even illumination on walls or ceilings without glare.

Three power level options available to accommodate power and lighting appropriately to applications.

Power:	Up to 53W
Lumens:	Up to 930 lm/ft
Comparable to:	T5HO (using elements at Power Level 3)
Dimming:	100% - 0.1%
Input:	48V DC
Rated Life:	50,000 hours



TITLE 24
CALIFORNIA



SMOOTH, EVEN DISTRIBUTION

With asymmetrical beam distribution, we've engineered our wall wash fixtures to provide even illumination both horizontally and vertically.

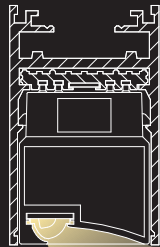

Horizontal spread
Even coverage
for greater fixture
spacing

Vertical spread
Illumination from top
to bottom of wall

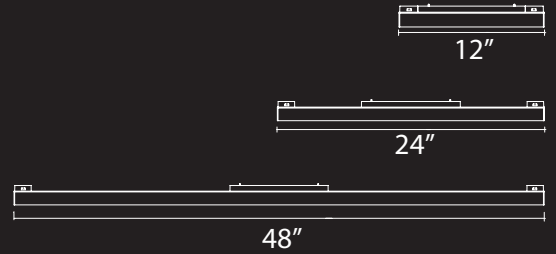

STEALTH WALL WASH

System	Model	Length	Power	Max Lumens	Beam	Color Temp	CRI	Finish	
S2	WW Linear Wall Wash	12	12" 1	7.0W	500	ASY	A927 2700K A930 3000K A935 3500K A940 4000K	90	BK Black
			12" 2	10.5W	690				
			12" 3	14.5W	930				
		24	24" 1	12.0W	910				
			24" 2	19.5W	1,350				
			24" 3	27.5W	1,810				
		48	48" 1	24.0W	1,820				
			48" 2	35.0W	2,700				
			48" 3	53.0W	3,630				

Example: **S2WW12-1-A940BK**

WALL WASH ELEMENT LENGTH / AVERAGE WALL ILLUMINANCE			
8' CEILING		3000K	1', 2', 4'
DISTANCE FROM WALL	3'	Power 1	28 fc
		Power 2	41 fc
		Power 3	55 fc
	4'	Power 1	24 fc
		Power 2	36 fc
		Power 3	48 fc

Data shown represents wall wash fixtures installed end-to-end for most consistent linear performance.



MULTI STEALTH DOWNLIGHTS

DEPTH AND DIMENSION

Powerful but discreet contrast illumination.

Our multi stealth downlights feature a quiet aperture for a nearly glare free environment. With multiple lumen packages, beam and finish options, these downlights complement other elements in your STRUT array. Three power level options available to accommodate power and lighting appropriately to applications.

Power:	Up to 21.5W
Lumens:	Up to 1,120 lm/ft
Dimming:	100% - 0.1%
Input:	48V DC
Rated Life:	50,000 hours



TITLE 24
CALIFORNIA

QUIET CEILING

A circular blanket of coverage in a single size downlight, all while keeping the glare so low, you won't even know where the light is coming from. Reference: 6" Stealth Multi Downlight (Power Level 3)





SMALL, BUT MIGHTY

These tiny downlights work together to provide a beautiful, even glow. Try to find any sign of glare, and maybe you'll get close enough to see where the light is coming from.

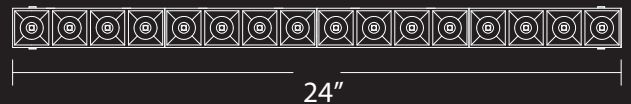
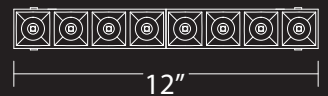
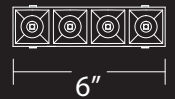

MULTI STEALTH DOWNLIGHTS

Model	Size	# of Lights	Power	Max Lumens	Max CBCP	Beam	Color Temp	CRI	Finish	
S2 MD06	6"	4	1	3.5W	380	1,820	S 16°	927 2700K	90	BK Black
			2	5.0W	450	2,570	N 32°	930 3000K		CH Chrome
			3	6.0W	560	2,900	F 45°	935 3500K 940 4000K		GL Gold HZ Haze
S2 MD12	12"	8	1	5.5W	730	3,970	S 16°	927 2700K	90	BK Black
			2	8.0W	960	4,870	N 32°	930 3000K		CH Chrome
			3	10.5W	1080	5,490	F 45°	935 3500K 940 4000K		GL Gold HZ Haze
S2 MD24	24"	16	1	10W	1470	6,600	S 16°	927 2700K	90	BK Black
			2	15.5W	1840	8,830	N 32°	930 3000K		CH Chrome
			3	21.5W	2190	9,940	F 45°	935 3500K 940 4000K		GL Gold HZ Haze

Example: **S2MD12-1-F930BK**

BLACK

CHROME



GOLD

HAZE



REPLACEMENT TRIMS

Black Trim 6"	REF-S2MD06-BK
Chrome Trim 6"	REF-S2MD06-CH
Gold Trim 6"	REF-S2MD06-GL
Haze Trim 6"	REF-S2MD06-HZ

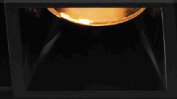

STEALTH DOWNLIGHT

CONTRAST ELEMENT

Ample comfortable illumination.

Installed anywhere along a channel or side by side in pairs, Stealth Downlights provide clear, task illumination with virtually no glare. Finish options complement other elements in your STRUT array, and field changeable optics and trims add another level of design customization.

Power:	8.5W
Lumens:	Up to 650 lm
Comparable to:	50W MR16
Dimming:	100% - 0.1%
Input:	48V DC
Rated Life:	50,000 hours



TITLE 24
CALIFORNIA

ONE OR TWO OR MORE

Add multiple downlights side by side or anywhere along your STRUT system.



DESIGNER OPTICS

A patent-pending reflector curve for glare control and a variety of luxurious finishes customizes to each design.

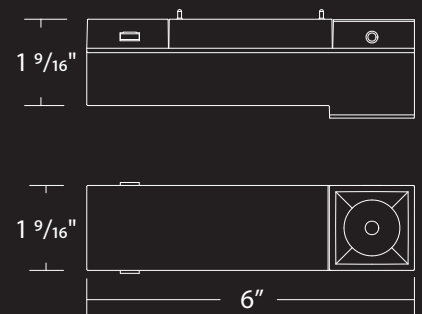

STEALTH DOWNLIGHT

System	Model	Power	Beam	Color Temp	CRI	Max Lumens	Max CBCP	Finish
S2	SD-1	8.5W	S 19°	927 2700K	90	650	2720	BK Black
			N 32°	930 3000K				CH Chrome
			F 50°	935 3500K				GL Gold
				940 4000K				HZ Haze

Example: **S2SD-1-S930BK**

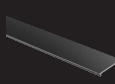
	Channel Cover 8ft 8ft length may be field cut, Suitable for top or bottom channel coverage.	S2C-COV08	BK WT	Black White
---	--	------------------	------------------------	----------------

REPLACEMENT TRIMS

Black Trim	REF-S2SD02-BK
Chrome Trim	REF-S2SD02-CH
Gold Trim	REF-S2SD02-GL
Haze Trim	REF-S2SD02-HZ

BLACK



CHROME



GOLD



HAZE

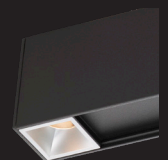

STEALTH SILO

UNMATCHED VERSATILITY

A patent-pending accent light or downlight - change your mind on the fly.

These luminaires can be used as accent lights or downlights. With beam shaping options between 15° and 50°, and a variety of available glare control accessories, these Stealth Silo elements are truly dynamic.

Power:	6.5W
Lumens:	Up to 430 lm
Comparable to:	35W MR11
Dimming:	100% - 0.1%
Input:	48V DC
Rated Life:	50,000 hours



TITLE 24
CALIFORNIA

BOTH.

These lights extend from STRUT channel for accenting or fully retract within channels for a downlight configuration. 90° vertical and 360° horizontal aiming, with a continuously adjustable beam angle between 15°-50°.

RETRACTABLE



ADJUSTABLE 15°-50°

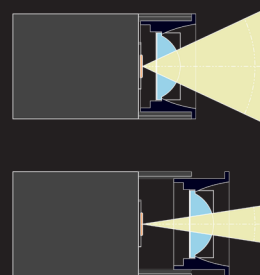

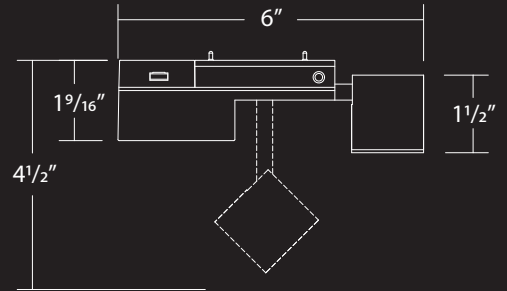

STEALTH SILO

System	Model	Power	Beam	Color Temp	CRI	Max Lumens	Max CBCP	Finish		
S2	SS	1	6.5W	15°-50°	927	2700K	90	430	2,320	BK Black WT White
					930	3000K				
					935	3500K				
					940	4000K				

Example: **S2SS-1-930BK**

Accessories: Accepts one glare control accessory

ACCESSORY HOLDER

sold separately

LENS-S211-HLD-BK
LENS-S211-HLD-WT

Required for use with any accessory

GLARE CONTROL ACCESSORIES

sold separately

Honeycomb Louver

LENS-11-HCM

Cross Louver

LENS-11P-CRL-BK
LENS-11P-CRL-WT

Snoot

LENS-11-SNOOT-BK
LENS-11-SNOOT-WT



SILO

DYNAMIC FOCUS OR FIXED BEAM

Superior light output in a small, unobtrusive design.

Adjustable accent elements with your choice of 15°-40° dynamic focus or Fixed Beam high lumen output elements at 15° Spot, 25° Narrow Flood, or 35° Flood with TIR lenses. Glare control and lens accessories give you even greater control.

Power:	15W
Lumens:	Up to 1,230 lm
Comparable to:	75W MR16
Dimming:	100% - 0.1%
Input:	48V DC
Rated Life:	50,000 hours



TITLE 24
CALIFORNIA

Continuously adjustable beam angles from 15° to 40°

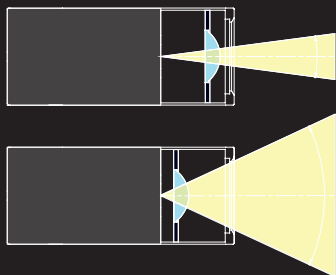

SHAPE YOUR BEAM

With 90° vertical and 360° horizontal aiming, and a continuously adjustable beam angle from 15°-40°, you've got options.

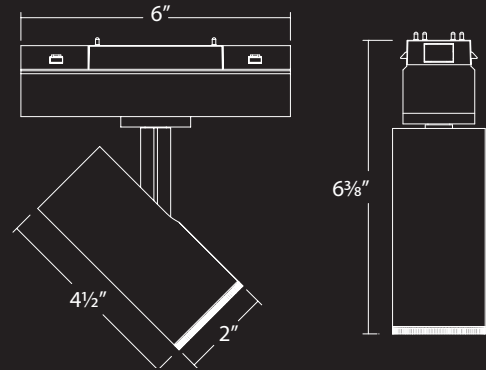

ADJUSTABLE SPOT LIGHT

System	Model	Power	Beam	Color Temp	CRI	Max Lumens	Max CBCP	Finish			
S2	SA	1	15W	15° - 40°	927	2700K	90	810	2,870	BK	Black
					930	3000K					
					935	3500K					
					940	4000K					
									WT	White	

Example: **S2SA-1-930BK**

Accessories: Accepts one lens or glare control accessory

FIXED BEAM SPOT LIGHT

System	Model	Power	Beam	Color Temp	CRI	Max Lumens	Max CBCP	Finish		
S2	SA	1	15W	S	15°	90	1,230	9,400	BK	Black
				N	25°					
				F	35°					
				927	2700K					
									WT	White
				930	3000K					
				935	3500K					
				940	4000K					

Example: **S2SA-1-S930BK**

Accessories: Accepts one lens or glare control accessory

LENS ACCESSORIES

sold separately

Amber	LENS-11-AMB
Blue	LENS-11-BLU
Green	LENS-11-GRN
Red	LENS-11-RED
Frosted	LENS-11-FR
Spread	LENS-11-SPR
Beam Elongating	LENS-11-BEL

GLARE CONTROL ACCESSORIES

sold separately

Honeycomb Louver	LENS-11-HCM
Cross Louver	LENS-11P-CRL-BK LENS-11P-CRL-WT
Snoot	LENS-11-SNOOT-BK LENS-11-SNOOT-WT



FOLLOWME SILO MOTORIZED ELEMENT

A smart responsive moving spotlight.

This patent-pending smart tracking adjustable spotlight is the final touch to getting the most out of your intelligent STRUT system. Wireless 360° panning, 0-90° tilting, and 15-40° beam angle adjustment. Glare control and lens accessories are also available for even more control.

Power:	15W
Lumens:	Up to 1,000 lm
Comparable to:	75W MR16
Dimming:	100% - 0.1%
Input:	48V DC
Rated Life:	50,000 hours



NO LADDER
REQUIRED

FOLLOWME SILO features automated beam adjustment, motorized head adjustment, and a multitude of accessories.

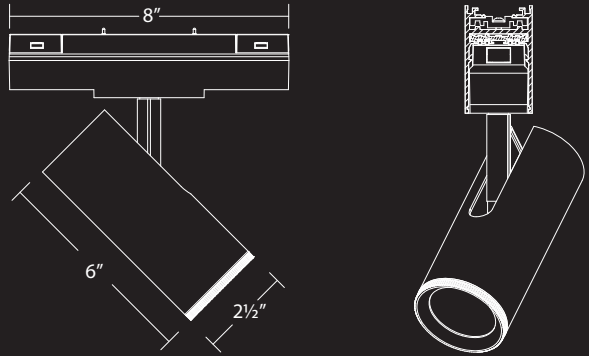

FOLLOWME SILO

System	Model	Power	Beam	Color Temp	CRI	Max Lumens	Max CBCP	Finish			
S2	FM	1	15W	15 ° - 40 °	927	2700K	90	1,000	16,000	BK	Black
					930	3000K					
					935	3500K					
					940	4000K					
									WT	White	

Example: **S2FM-1-927BK**

LENS ACCESSORIES

sold separately

Amber	LENS-16-AMB
Blue	LENS-16-BLU
Green	LENS-16-GRN
Red	LENS-16-RED
Frosted	LENS-16-FR
Spread	LENS-16-SPR
Beam Elongating	LENS-16-BEL

GLARE CONTROL ACCESSORIES

sold separately

Honeycomb Louver	LENS-16-HCM
Cross Louver	LENS-16P-CRL-BK LENS-16P-CRL-WT
Snoot	LENS-16-SNOOT-BK LENS-16-SNOOT-WT

SILO PENDANT

12" & 14" CYLINDERS

Combining our beloved Silo adjustable beam pendant with STRUT system.

A patent-pending technical, high-performing pendant that offers dynamic height adjustment and beam shaping from 15° – 45°. Available in Black or White cylinders, choose from 2 sizes and 3 finishes for the retractable accent collar.

Power:	Up to 20W
Lumens:	Up to 1,170lm
Dimming:	100% - 0.1%
Input:	48V DC
Rated Life:	50,000 hours



TITLE 24
CALIFORNIA

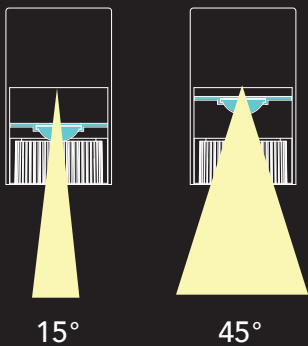

Shape beam from 15° to 45°

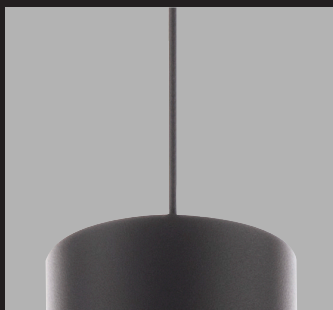

Suspension cable retracts inside fixture body for precise height adjustment.

SLEEK, FULLY ADJUSTABLE DESIGN

Available in multiple finishes, Silo features a retracting accenting collar, effortless height adjustment, and continuous 15°-45° beam angle selection.



AVAILABLE COLLAR FINISHES



WHITE



BLACK



GOLD



S2PD01-1

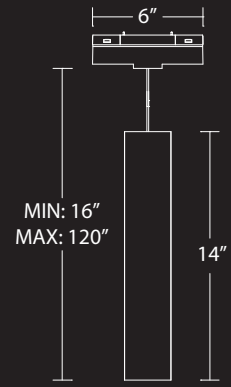

S2PD01-2

SILO PENDANTS

System	Model	Power	Size	Beam	Color Temp	CRI	Max Lumens	Max CBCP	Finish	Body/Collar		
S2	PD01	15W	1	12"	15° - 45°	927	2700K	90	760	3,220	BK BK	Black/Black
						930	3000K				BK GL	Black/Gold
						935	3500K				BK WT	Black/White
						940	4000K				WT BK	White/Black
											WT GL	White/Gold
											WT WT	White/White
S2	PD01	20W	2	14"	15° - 45°	927	2700K	90	1,170	6,560	BK BK	Black/Black
						930	3000K				BK GL	Black/Gold
						935	3500K				BK WT	Black/White
						940	4000K				WT BK	White/Black
											WT GL	White/Gold
											WT WT	White/White

Example: **S2PD01-1-927BK BK**

REPLACEMENT COLLARS

PD01-1 Black Collar	M2015-C-BK
PD01-1 Gold Collar	M2015-C-GL
PD01-1 White Collar	M2015-C-WT
PD01-2 Black Collar	M2020-C-BK
PD01-2 Gold Collar	M2020-C-GL
PD01-2 White Collar	M2020-C-WT

Optional hook is available to suspend pendants apart from the architectural channels.

Hook	System	Size	Model	Finish
	S2	1"x1 1/2"	PD-HOOK	BK WT Black White

Example: **S2PD-HOOK-BK**

NIVEOUS PENDANT

LUMINOUS ORB ELEMENT

Add a playful element to the design with our Niveous pendant. Etched opal glass in a perfect sphere, Niveous provides ample ambient illumination. Offered in 2700K, 3000K, 3500K, and 4000K for design continuity with other light sources within the system.



Power:	Up to 11W
Lumens:	Up to 1,140 lm
Dimming:	100% - 0.1%
Input:	48V DC
Rated Life:	50,000 hours



TITLE 24
CALIFORNIA

For precise height adjustment, suspension cable retracts 6" inside fixture adapter.





SIMPLE PURITY

With flawless etched triplex opal mouthblown glass, Niveous achieves a perfect sphere of even illumination.

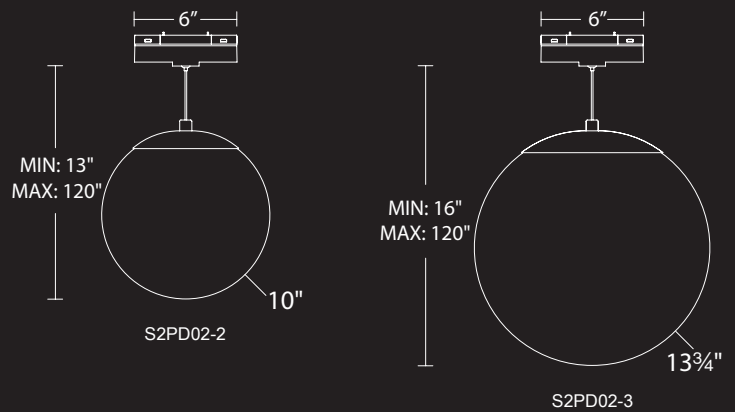

NIVEOUS PENDANTS

System	Model	Size	Power	Color Temp	CRI	Max Lumens	Finish		
S2	PD02	2 10"	11W	927	2700K	90	1,140	BK SN WT	Black Satin Nickel White
				930	3000K				
				935	3500K				
				940	4000K				
S2	PD02	3 13"	11W	927	2700K	90	1,140	BK SN WT	Black Satin Nickel White
				930	3000K				
				935	3500K				
				940	4000K				

Example: **S2PD02-2-927BK**

Optional hook is available to suspend pendants apart from the architectural channels.

Hook	System	Size	Model	Finish
	S2	1"x1 1/2"	PD-HOOK	BK WT Black White

Example: **S2PD-HOOK-BK**

ELEMENTUM PENDANT

LUMINOUS LED CYLINDER

Perfect for drawing attention to areas central to interaction, be it a retail cashier counter, a registration desk, or a collaborative workspace. Evenly lit etched opal glass in coordinating color temperatures and 90 CRI. The aluminum hardware is available in either Black, White or Satin Nickel to complement interior finishes.

Power:	18W
Lumens:	Up to 1,780lm
Dimming:	100% - 0.1%
Input:	48V DC
Rated Life:	50,000 hours



TITLE 24
CALIFORNIA

For precise height adjustment, suspension cable retracts 6" inside fixture adapter.



LIGHT AND STYLE

Elementum features an aluminum construction and an etched opal glass diffuser that provides even illumination.

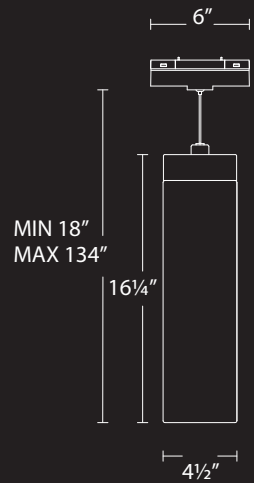

ELEMENTUM PENDANTS

System	Model	Size	Power	Color Temp	CRI	Max Lumens	Finish			
S2	PD03	2	4 1/2" x 16 1/4"	18W	927	2700K	90	1,780	BK	Black
					930	3000K			SN	Satin Nickel
					935	3500K			WT	White
					940	4000K				

Example: **S2PD03-2-927BK**



Optional hook is available to suspend pendants apart from the architectural channels.

Hook	System	Size	Model	Finish	
	S2	1" x 1 1/2"	PD-HOOK	BK WT	Black White

Example: **S2PD-HOOK-BK**

FLARE PENDANT

PILLARS OF LIGHT

Symmetrical, cylindrical and aerodynamic. A durable aluminum housing and polycarbonate diffuser provide 360 degrees of even illumination. Flare is right at home in your STRUT array, whether alone or in multiples.

Power:	Up to 32W
Lumens:	Up to 1,870lm
Dimming:	100% - 0.1%
Input:	48V DC
Rated Life:	50,000 hours



TITLE 24
CALIFORNIA

For precise height adjustment, suspension cable retracts 6" inside fixture adapter.



LUMINOUS OPTIONS

Symmetrical, cylindrical and aerodynamic.

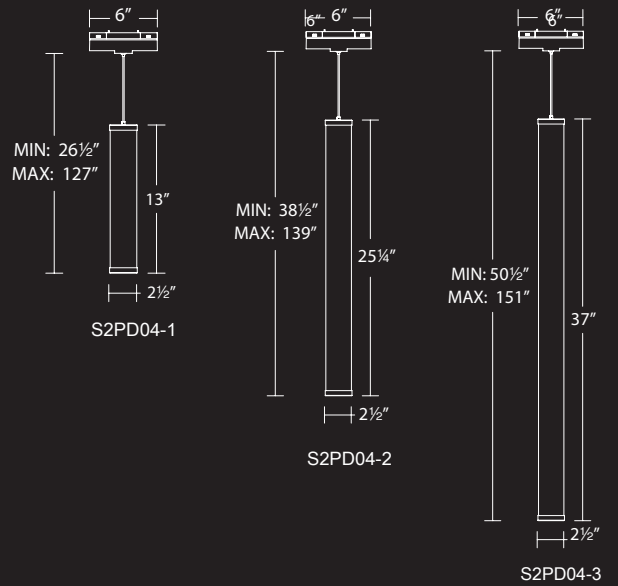

FLARE PENDANTS

System	Model	Size	Power	Color Temp	CRI	Max Lumens	Finish			
S2	PD04	1 13"	9W	930	3000K	90	590	BK	Black	
		2 25"	23W							1,270
		3 37"	32W							
							BN	Brushed Nickel		

Example: **S2PD04-1-930BK**

Optional hook is available to suspend pendants apart from the architectural channels.

Hook	System	Size	Model	Finish
	S2	1"x1 1/2"	PD-HOOK	BK WT Black White

Example: **S2PD-HOOK-BK**

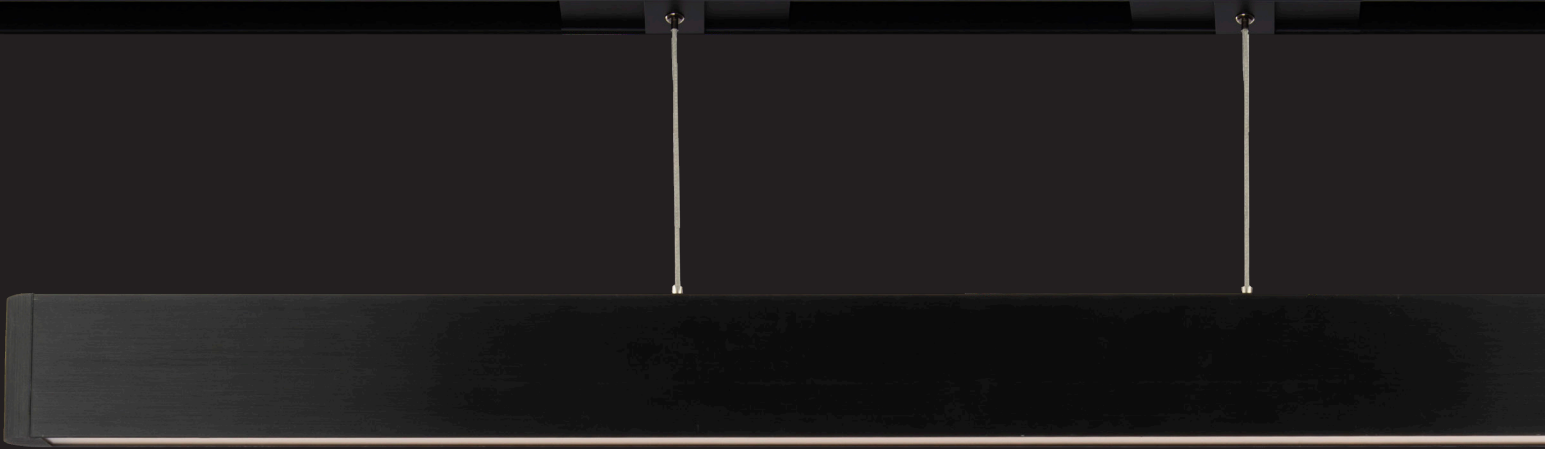

VOLO PENDANT

Sleek, linear and minimalist. An extruded aluminum body enables superior light output from evenly diffused LEDs for generous task illumination. Volo balances form and function, used individually or in groups. Field adjustable suspension cables. Dims beautifully.

Power:	Up to 25W
Lumens:	Up to 2,070lm
Dimming:	100% - 0.1%
Input:	48V DC
Rated Life:	50,000 hours



For precise height adjustment, suspension cable retracts 6" inside fixture adapter.



WISHFUL LIGHTING

Ultra thin pendant for the discerning minimalist

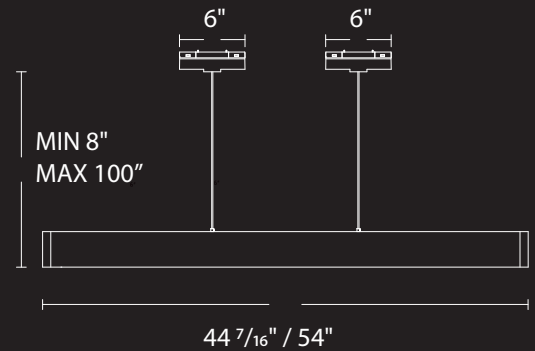

VOLO PENDANTS

System	Model	Size	Power	Color Temp	CRI	Max Lumens	Finish		
S2	PD05	1 44"	18W	927	2700K	90	1,590	AL BK	Brushed Aluminum Black
				930	3000K				
				935	3500K				
				940	4000K				
S2	PD05	2 54"	25W	927	2700K	90	2,070	AL BK	Brushed Aluminum Black
				930	3000K				
				935	3500K				
				940	4000K				

Example: **S2PD05-1-927BK**

Optional hook is available to suspend pendants apart from the architectural channels.

Hook	System	Size	Model	Finish
	S2	1"x1½"	PD-HOOK	BK WT Black White

Example: **S2PD-HOOK-BK**

CPU CONNECTED POWER UNIT

ENERGIZE

Accepts input ranges of 120-277V AC, and converts to a stable 48V DC output. Available in various wattages up to 600W to best accommodate system sizes and run lengths. Fixture drivers intelligently correct for minimum load or voltage drop concerns.

THE BRAINS AND THE BRAWN

The patent-pending Connected Power Unit (CPU) is the powerhouse of your STRUT system. It manages every aspect of STRUT and seamlessly integrates with smart systems you already own. A simple setup using our app for iOS or Android gets you online quickly and easily.

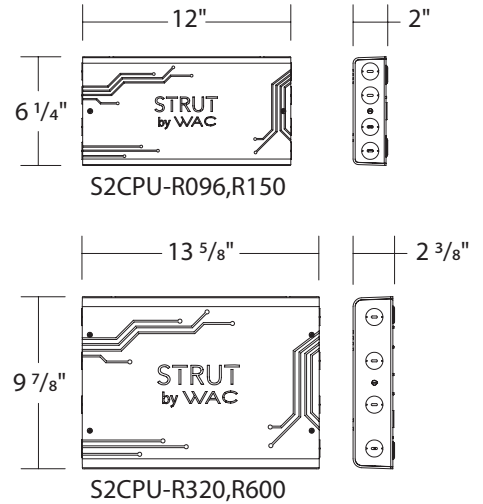
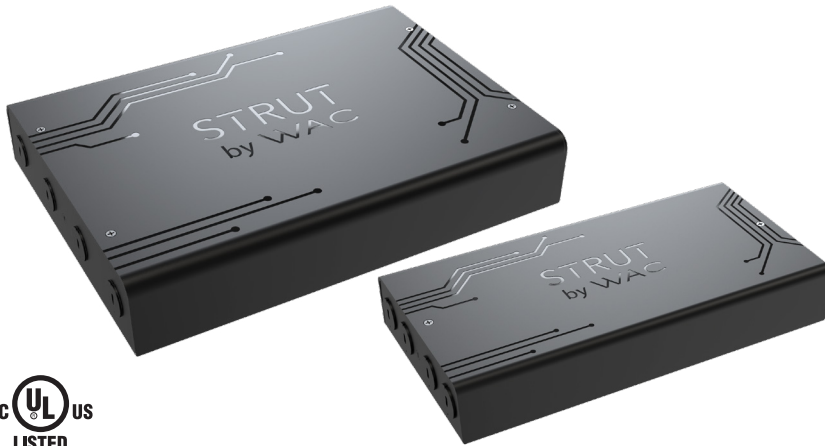

REMOTE CPU	System	Model	Power	Control Protocol		Finish
Suspended Channels Surface Channels Recessed Channels	S2CPU	R	096 96W Hardwired	S	0-10V, ELV, and TRIAC	BK Black
			150 150W Hardwired			
			320 320W Hardwired			
			600 600W Hardwired			
				X	DMX, 0-10V, ELV and TRIAC	
				Z	0-10V x4, ELV, and TRIAC	

Example: **S2CPU-R150-X-BK**

INTELLIGENCE

STRUT CPU enables 0-10V, ELV, TRIAC, and DMX dimming support for interfacing with control systems. Wireless communication to our app also allows users to control and group individual lighting and sensor elements in the STRUT system.

INSTALLATION

Install remotely or locally to either surface mounted or suspended STRUT system. Designed to seamlessly coordinate with system aesthetics.

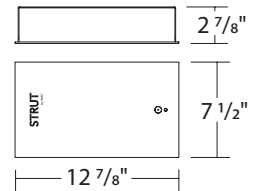
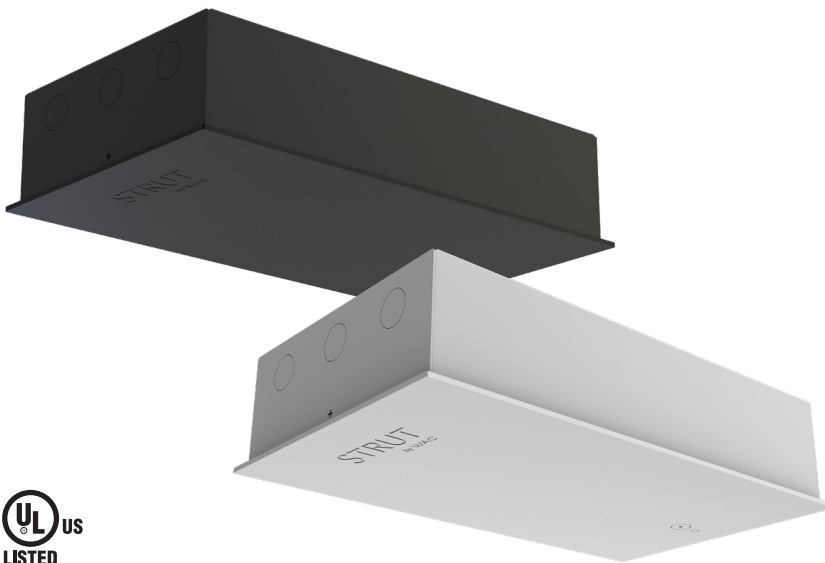

S2CPU-S096, S150

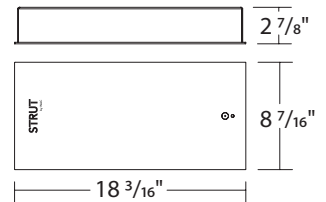

S2CPU-S320, S600

SURFACE MOUNT CPU	System	Model	Power	Control Protocol	Finish
Suspended Channels Surface Channels	S2CPU	S	096 96W	S X Z	0-10V, ELV, and TRIAC DMX, 0-10V, ELV and TRIAC 0-10V x4, ELV, and TRIAC
			150 150W		
			320 320W		
			600 600W		
					BK Black WT White

Example: **S2CPU-S320-S-WT**

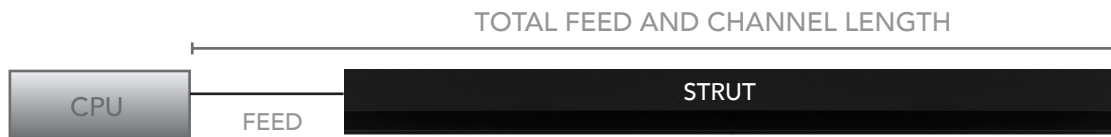

CONNECTED POWER UNIT RANGE				
POWER SUPPLY	96W	150W	320W	600W
TOTAL FEED AND CHANNEL LENGTH	200 ft	200 ft	200 ft	100 ft

Note: To meet EMC (electromagnetic compatibility) requirements, recommended for 150W, 320W, 600W total system power should be between 50%-95% of the CPU's capacity. Above calculations based on 12 AWG power wires and 16 AWG data wires.



VACANCY/PHOTO SENSOR

Two devices in one. A vacancy sensor tuned for human detection in a space and a state-of-the-art ambient light sensor combined in one discreet package that uses the STRUT wired communications to relay information back to the CPU. Installs anywhere within the system irrespective of the elements it will be controlling. Pair after installation. Sensitivity can be adjusted in the WAC app.



S2SN-1-BK

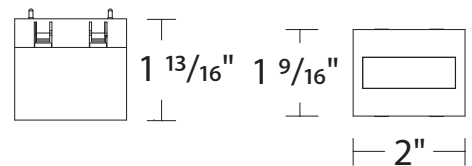

DAY AND NIGHT

Perfect for open office designs and other community spaces, STRUT incorporates combination vacancy/photo sensors to maximize daylight harvesting and reduce energy consumption.

Working late? STRUT can also give each occupant control over their own task lighting with SILO Adjustable pendants while integrating illumination of pathways and common areas with layered lighting.

SENSOR

<i>Vacancy and Photo sensor</i>	S2SN-1	BK <i>Black</i>
---------------------------------	---------------	------------------------

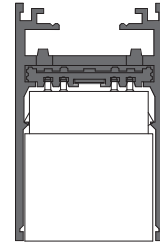

TRIG

MAKE PATTERNS AS UNIQUE AS YOU

There's no need to order complicated connectors. Our patent-pending TRIG hub system features six connection points that allow you to make a variety of patterns on the ceiling or on the wall.



Create your own unique patterns in a space without having to worry about dissonance. TRIG connectors have a switch to maintain pattern polarity. All of our components are engineered to work in perfect harmony with one another.

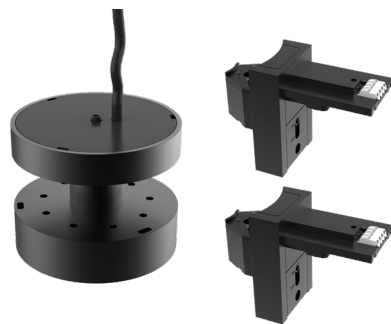

PATENT-PENDING I-CONNECTOR





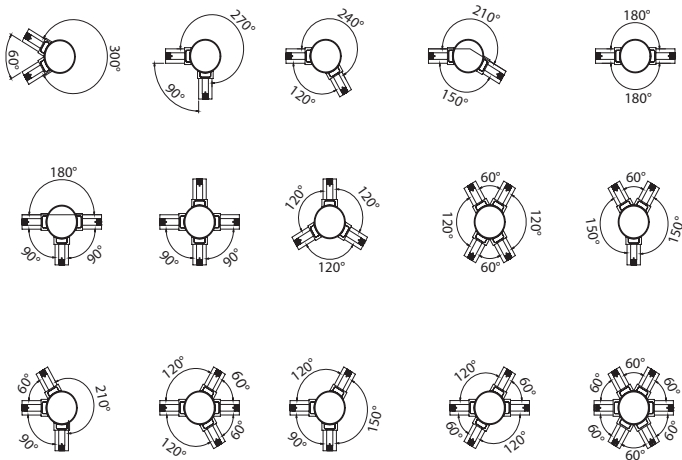

Power Feeds connect on top of the channel for uninterrupted runs.

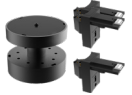

Add up to 6 connectors to fully customize your pattern.

CONNECTORS

	<p>Trig with Feed Includes 96in feed wire, and 2 channel connectors. Suspension Hardware sold separately. Aircraft cable only.</p>	<p>S2CPS-FTRIG</p>	<p>BK Black WT White</p>
	<p>Trig Includes 2 channel connectors. Suspension Hardware sold separately. Stem and Aircraft cable compatible.</p>	<p>S2CPS-TRIG</p>	<p>BK Black WT White</p>
	<p>Adapter Additional Trig connectors</p>	<p>S2CPS-NADP</p>	<p>BK Black WT White</p>
	<p>I Connector Joins two sections of channel with electrical continuity</p>	<p>S2CP-I</p>	<p>BK Black WT White</p>
	<p>Dead I Connector Joins two sections of channel without electrical continuity</p>	<p>S2C-ID</p>	<p>BK Black WT White</p>

Dead I Connector available for separating power and data lines while keeping mechanical connection.

BUILD IT

CHOOSE YOUR CHANNELS AND CONNECTORS

- Power feed from feed end channel or feed end junction box to energize your run.
- Support Strut with screws into rear blocking, 1/4"-20 tie rod (by others), or stem or aircraft cables to plenum ceiling. Minimum two supports per 4ft section. Minimum three supports per 8ft and 12ft section.
- For patterns, choose L, T, X, or corners.

Note: STRUT is field cut at end of run. For patterns and custom length channels, consult factory.

CHOOSE YOUR ELEMENTS

- Refer to element specifications to appropriately select elements.
- Total the wattage of the system.

CHOOSE YOUR CONNECTED POWER UNIT (CPU)

- Select remote mount CPU.
- Select appropriate wattage based on total system wattage.

Note: recommended sizing up as feasible for increased system capability.

ACCESSORIZE

- Add channel covers, lenses, or glare control accessories as desired.

A	S2CT08-FE	8FT FEED END RECESSED CHANNEL	G	S2CT-IC	RECESSED INSIDE CORNER
B	S2CT12	12FT RECESSED CHANNEL	H	S2CR-CLIP	1/4"-20 TIE ROD MOUNTING CLIP
C	S2CT04	4FT RECESSED CHANNEL	I	S2C-S96	STEM SUSPENSION
D	S2CT08	8FT RECESSED CHANNEL	J	S2C-C96	CABLE SUSPENSION
E	S2CSR-I	I CONNECTOR	K	S2CPU-R320-S-BK	REMOTE CPU
F	S2CT-L	RECESSED L CONNECTOR	L	BY OTHERS	FIELD WIRING TO CPU

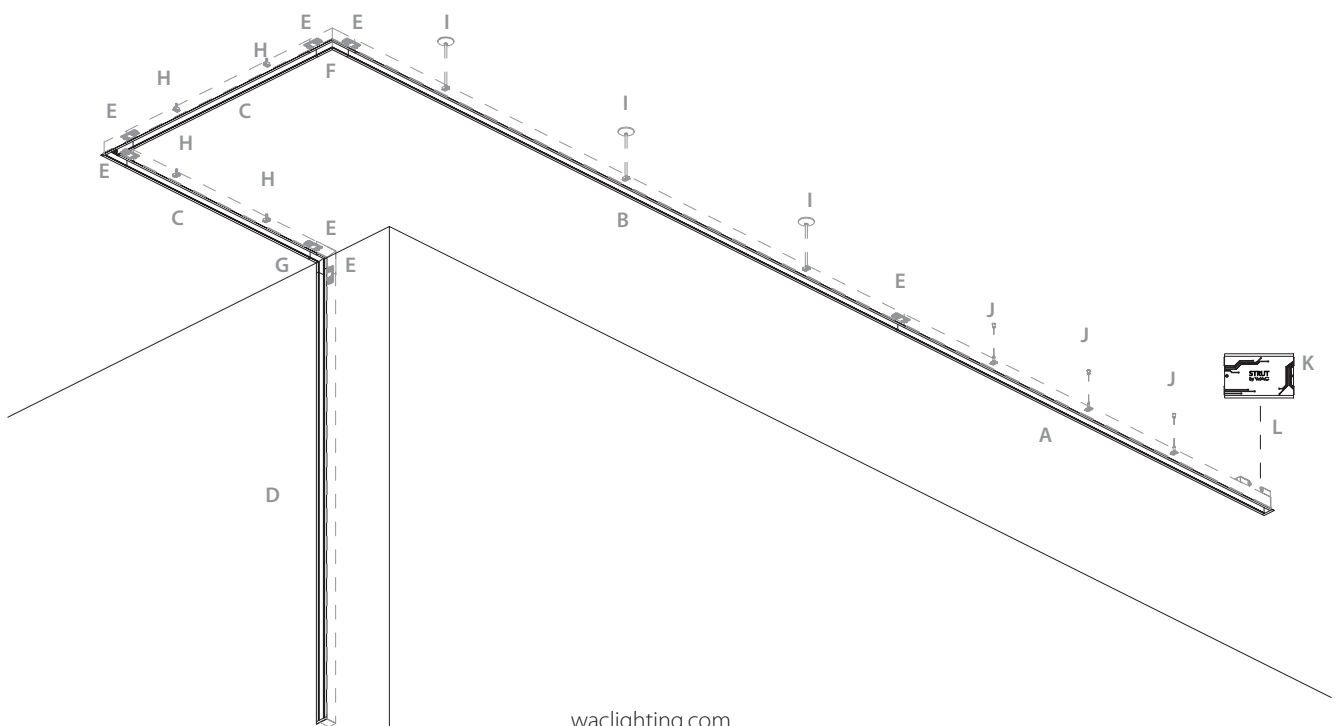

POWER FEED END RECESSED CHANNELS WITH TRIM

System	Model	Description	Finish
S2	CT04-FE	4 ft Trim Recessed Feed End	Required Power Feed Run Connected Power Unit Required See page 44 (sold separately)
	CT08-FE	8 ft Trim Recessed Feed End	
	CT12-FE	12 ft Trim Recessed Feed End	
			BK Black WT White

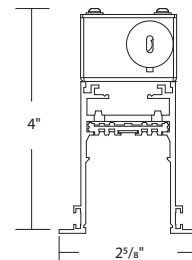

Example: **S2CT04-FE-BK** Each section comes with two matching end caps and may be cut at end run.

RECESSED CHANNELS WITH TRIM

System	Model	Description	Finish
S2	CT01	1 ft Trim Recessed Channel	To extend channel runs after feed end
	CT01.5	1.5 ft Trim Recessed Channel	
	CT04	4 ft Trim Recessed Channel	
	CT08	8 ft Trim Recessed Channel	
	CT12	12 ft Trim Recessed Channel	
			BK Black WT White

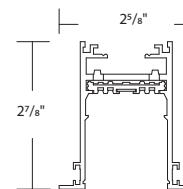





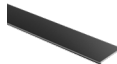



Example: **S2CT08-BK** Each section comes with two matching end caps and may be cut at end run.



CHANNEL COVER

	Channel Cover 8ft 8ft length may be field cut, Suitable for top or bottom channel coverage.	S2C-COV08	BK Black WT White
--	---	------------------	------------------------------------

CONNECTORS

	Model	Finish
 Feed End Junction Box 5in junction box with side knockouts	S2CT-FEB	BK Black WT White
 I Connector Joins two channel sections with electrical continuity	S2CSR-I	BK Black
 Dead I Connector Joins two channel sections without electrical continuity	S2C-ID	BK Black
 L Connector Joins two channel sections 90°	S2CT-L	BK Black WT White
 T Connector Joins three channel sections	S2CT-T	BK Black WT White
 X Connector Joins four channel sections	S2CT-X	BK Black WT White
 Inside Corner Joins ceiling to wall channel sections	S2CT-IC	BK Black WT White
 Outside Corner Joins wall to wall channel sections	S2CT-OC	BK Black WT White

CONNECTORS

	Model	Finish
 Surface/Suspended to Recessed Corner Joins suspended or surface mounted channel to recessed channel	S2CPST-IC	BK Black BK Black WT White WT White WT Black
 End Cap Additional end cap	S2CT-EC	BK Black WT White

SUSPENSION HARDWARE

	Model	Finish
 Mount Clip Support recessed channel with 1/4 - 20 threaded rod (rod by others)	S2CR-CLIP	BK Black
 Cable Suspension Support recessed channel from plenum ceiling. Includes 96in aircraft cable; may be field cut	S2C-C96	BK Black
 Stem Suspension Support recessed channel from plenum ceiling. Includes two 48in stem; may be field cut	S2C-S96	BK Black
 Suspension Loop Mechanical loop Supports up to 15 lb	S2C-LOOP	BK Black

BUILD IT

CHOOSE YOUR CHANNELS AND CONNECTORS

- Power feed from feed end channel or feed end junction box to energize your run.
- Support Strut with screws into rear blocking, 1/4"-20 tie rod (by others), or stem or aircraft cables to plenum ceiling. Minimum two supports per 4ft section. Minimum three supports per 8ft and 12ft section.
- For patterns, choose L, T, X, or corners.

Note: STRUT is field cut at end of run. For patterns and custom length channels, consult factory.

CHOOSE YOUR ELEMENTS

- Refer to element specifications to appropriately select elements.
- Total the wattage of the system.

CHOOSE YOUR CONNECTED POWER UNIT (CPU)

- Select remote mount CPU.
- Select appropriate wattage based on total system wattage.

Note: recommended sizing up as feasible for increased system capability.

ACCESSORIZE

- Add channel covers, lenses, or glare control accessories as desired.

A	S2CL08-FE	8FT FEED END RECESSED TRIMLESS CHANNEL	G	S2CL-OC	RECESSED TRIMLESS OUTSIDE CORNER
B	S2CL04	4FT RECESSED TRIMLESS CHANNEL	H	S2CR-CLIP	1/4"-20 TIE ROD MOUNTING CLIP
C	S2CL08	8FT RECESSED TRIMLESS CHANNEL	I	S2C-C96	CABLE SUSPENSION
D	S2CSR-I	I CONNECTOR	J	S2C-S96	STEM SUSPENSION
E	S2CL-IC	RECESSED TRIMLESS INSIDE CORNER	K	S2CPU-R600-S-BK	REMOTE CPU
F	S2CL-L	RECESSED TRIMLESS L CONNECTOR	L	BY OTHERS	FIELD WIRING TO CPU

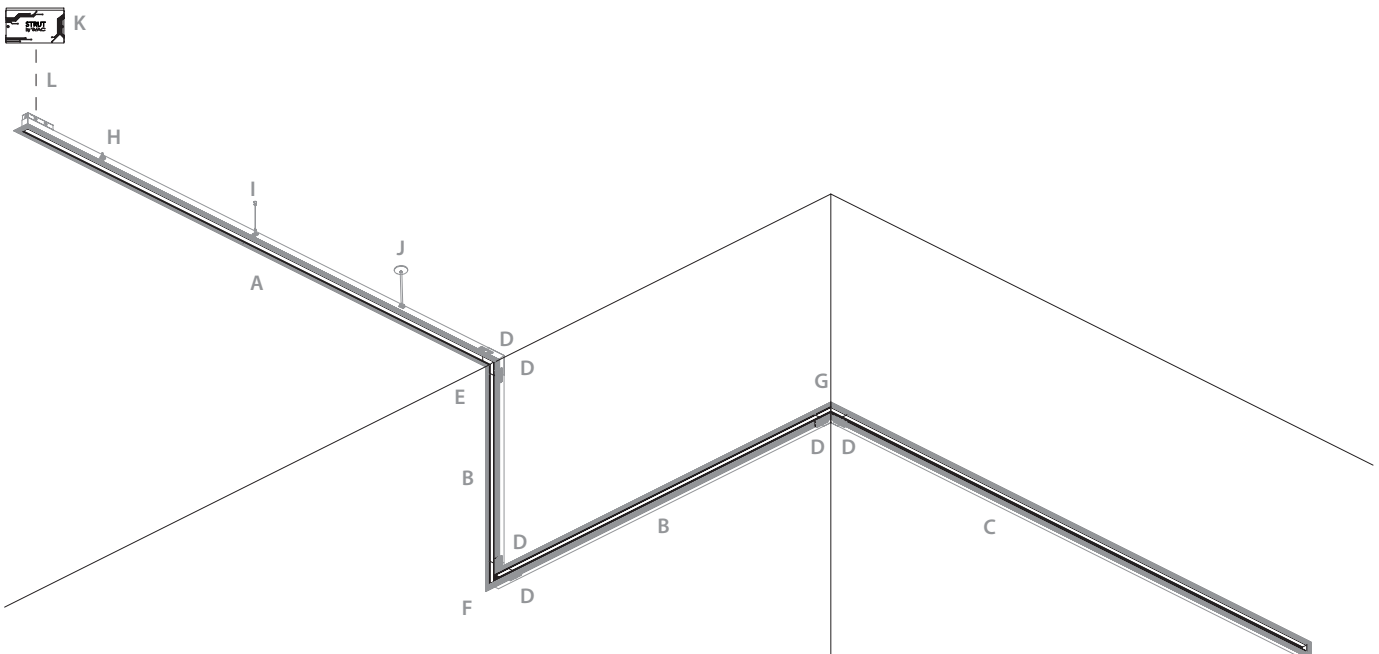

POWER FEED END RECESSED TRIMLESS CHANNELS

System	Model	Description	Finish
S2	CL04-FE	4 ft Trimless Recessed Feed End	Required Power Feed Run Connected Power Unit Required See page 44 (sold separately)
	CL08-FE	8 ft Trimless Recessed Feed End	
	CL12-FE	12 ft Trimless Recessed Feed End	
			BK Black

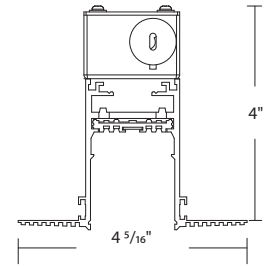

Example: **S2CL04-FE-BK** Each section comes with two matching end caps and may be cut at end run.

RECESSED TRIMLESS CHANNELS

System	Model	Description	Finish
S2	CL01	1 ft Trimless Recessed Channel	To extend channel runs after feed end
	CL01.5	1.5 ft Trimless Recessed Channel	
	CL04	4 ft Trimless Recessed Channel	
	CL08	8 ft Trimless Recessed Channel	
	CL12	12 ft Trimless Recessed Channel	
			BK Black

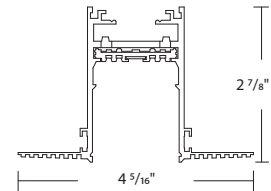

Example: **S2CL12-BK** Each section comes with two matching end caps and may be cut at end run.

CHANNEL COVER

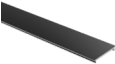
	Channel Cover 8ft 8ft length may be field cut, Suitable for top or bottom channel coverage.	S2C-COV08	BK Black
--	---	------------------	-----------------





CONNECTORS

	Model	Finish
 Feed End Junction Box 5in junction box with side knockouts. Includes BK and WT covers	S2CL-FEB	
 I Connector Joins two channel sections with electrical continuity	S2CSR-I	BK Black
 Dead I Connector Joins two channel sections without electrical continuity	S2C-ID	BK Black
 L Connector Joins two channel sections 90°	S2CL-L	BK Black
 T Connector Joins three channel sections	S2CL-T	BK Black
 X Connector Joins four channel sections	S2CL-X	BK Black
 Inside Corner Joins ceiling to wall channel sections	S2CL-IC	BK Black
 Outside Corner Joins wall to wall channel sections	S2CL-OC	BK Black

CONNECTORS

	Model	Finish
 Surface/Suspended to Recessed Corner Joins suspended or surface mounted channel to recessed trimless channel	S2CPSL-IC	BK Black WTBK White/Black
 End Cap Additional end cap	S2CL-EC	BK Black

SUSPENSION HARDWARE

	Model	Finish
 Mount Clip Support recessed channel with 1/4 - 20 threaded rod (rod by others)	S2CR-CLIP	BK Black
 Cable Suspension Support recessed channel from plenum ceiling. Includes 96in aircraft cable; may be field cut	S2C-C96	BK Black
 Stem Suspension Support recessed channel from plenum ceiling. Includes two 48in stem; may be field cut	S2C-S96	BK Black
 Suspension Loop Mechanical loop Supports up to 15 lb	S2C-LOOP	BK Black

BUILD IT

CHOOSE YOUR CHANNELS AND CONNECTORS

- Power feed from end with S2CP-FE, the middle with S2CP-FI, or from the TRIG with S2CPS-FTRIG to energize your run.
- Support Strut with cable or stem suspensions. Minimum two supports per 4ft and 8ft sections. Minimum three supports per 12ft section.
- For patterns, use the TRIG or L, T, X connectors. TRIG connector can accept as few as two and as many as six connections. Order additional TRIG or L, T connectors as needed. TRIG connectors have a switch to maintain pattern polarity.

Note: STRUT is field cut at end of run. For patterns and custom length channels, consult factory.

CHOOSE YOUR ELEMENTS AND/OR INDIRECT LIGHTING ELEMENTS

Note: Suspended strut is compatible with indirect lighting by default.

- Refer to element specifications to appropriately select elements
- Total the wattage of the system

CHOOSE YOUR CONNECTED POWER UNIT (CPU)

- Select remote mount or surface CPU
- Select appropriate wattage based on total system wattage.

Note: recommended sizing up as feasible for increased system capability.

ACCESSORIZE

- Add channel covers, lenses, or glare control accessories as desired.

A	S2CPS04	4FT SUSPENDED CHANNEL	F	S2C-FS96	STEM FEED SUSPENSION
B	S2CPS12	12FT SUSPENDED CHANNEL	G	S2C-S96	STEM SUSPENSION
C	S2CP-FE	FEED END	H	S2CPS-TRIG	TRIG
D	S2C-C96	CABLE SUSPENSION	I	S2CPU-R320-S-BK	REMOTE CPU
E	S2CP-CP	CABLE CANOPY	J	BY OTHERS	FIELD WIRING TO CPU

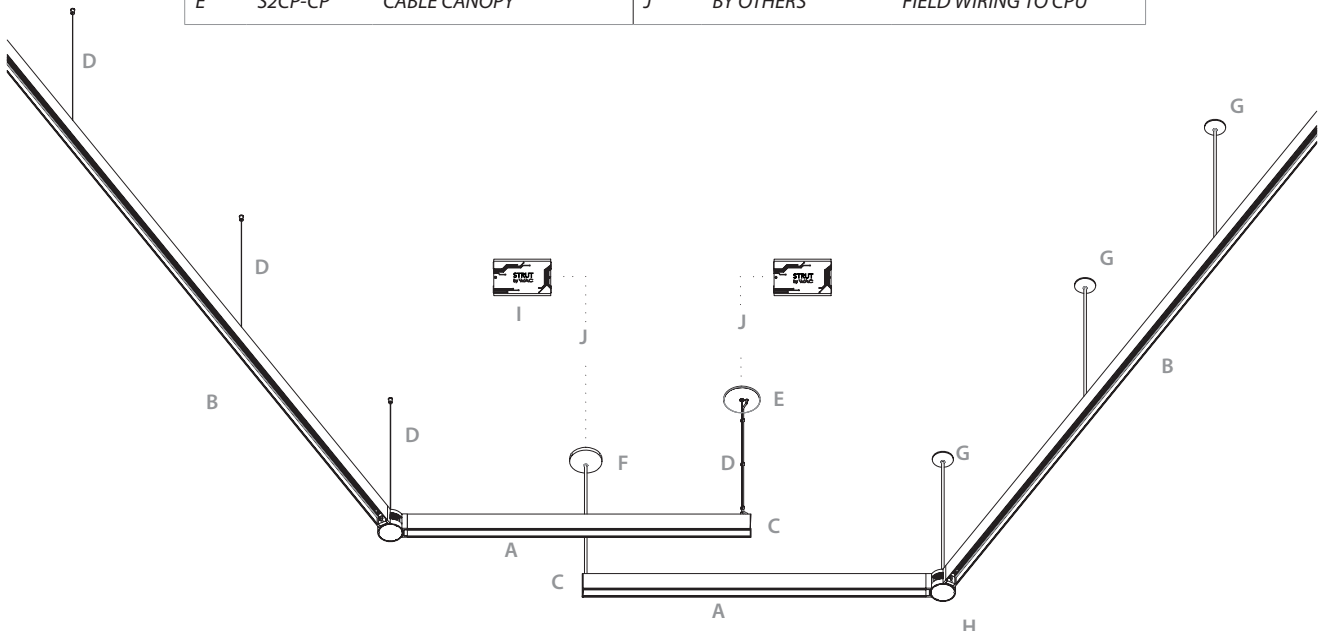

SUSPENDED CHANNELS

System	Model	Length	Finish
S2	CPS01	1 ft Suspended Channel	Direct and/or Indirect Compatible Connected Power Unit Required See page 44 (sold separately)
	CPS01.5	1.5 ft Suspended Channel	
	CPS04	4 ft Suspended Channel	
	CPS08	8 ft Suspended Channel	
	CPS12	12 ft Suspended Channel	
			BK Black WT White

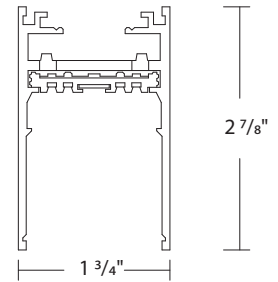

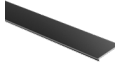

Example: **S2CPS08-BK** Each section comes with two matching end caps and may be cut at end run.

CHANNEL COVER



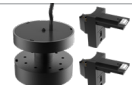
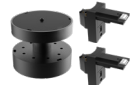





	Channel Cover 8ft 8ft length may be field cut, Suitable for top or bottom channel coverage.	S2C-COV08	BK Black WT White
---	---	------------------	------------------------------------

TRIG



	Model	Finish
 Trig with Feed Includes 96in feed wire, and 2 channel connectors. Suspension Hardware sold separately. Aircraft cable only.	S2CPS-FTRIG	BK Black WT White
 Trig Includes 2 channel connectors. Suspension Hardware sold separately. Stem and Aircraft cable compatible.	S2CPS-TRIG	BK Black WT White
 Adapter Additional Trig connectors	S2CPS-NADP	BK Black WT White

See page 46 for more information about the TRIG hub connector system







CONNECTORS

	Model	Finish
 Feed End Includes 96in feed wire and 10 wire guides	S2CP-FE	BK Black WT White
 I Connector with Feed Includes 96in of feed wire and 10 wire guides	S2CP-FI	BK Black WT White
 I Connector Joins two sections of channel with electrical continuity	S2CP-I	BK Black WT White
 Dead I Connector Joins two sections of channel without electrical continuity	S2C-ID	BK Black WT White
 L Connector Joins two channel sections 90°. Feed separately	S2CPS-L	BK Black WT White
 T Connector Joins three channel sections. Feed separately	S2CPS-T	BK Black WT White
 X Connector Joins four channel sections. Feed separately	S2CPS-X	BK Black WT White
 End Cap Additional end cap	S2CPS-EC	BK Black WT White

CONNECTORS

	Model	Finish
 Surface/Suspended to Recessed Corner Joins suspended or surface mounted channel to recessed trim channel	S2CPST-IC	BK BK Black/Black BK WT Black/White WT WT White/White WT BK White/Black
 Surface/Suspended to Recessed Corner Joins suspended or surface mounted channel to recessed trimless channel	S2CPSL-IC	BK BK Black/Black WT BK White/Black

SUSPENSION HARDWARE

	Model	Finish
 Cable Canopy Covers a standard 4in junction box. Use with cable feed connectors	S2CP-CP	BK Black WT White
 Cable Suspension Suspend channel from ceiling. Includes 96in aircraft cable; may be field cut	S2C-C96	BK Black NI Nickel
 Sloped Ceiling Cable Suspension Suspend channel from a sloped ceiling. Includes 96in aircraft cable; may be field cut	S2C-SC96	BK Black NI Nickel
 Stem Feed Suspension Suspend channel from ceiling with feed. Includes two 48in stem; may be field cut	S2C-FS96	BK Black WT White
 Stem Suspension Suspend channel from ceiling. Includes two 48in stem; may be field cut	S2C-S96	BK Black WT White
 Sloped Ceiling Stem Suspension Suspend channel from a sloped ceiling. Includes two 48in stem; may be field cut	S2C-SS96	BK Black WT White
 Suspension Loop Mechanical loop Supports up to 15 lb	S2C-LOOP	BK Black

BUILD IT

CHOOSE YOUR CHANNELS AND CONNECTORS

- Power feed from end with S2CS-FE or S2CS-FEB, or feed from the TRIG with S2CP-FTRIG to energize your run.
- Support with screws into support or joist. Minimum two supports per 4ft section. Minimum three supports per 8ft and 12ft section.
- For patterns, use the TRIG or L, T, X connectors. The TRIG connector can accept as few as two and as many as six connectors. Order additional TRIG or L, T connectors as needed. TRIG connectors have a switch to maintain pattern polarity.

Note: STRUT is field cut at end of run. For patterns and custom length channels, consult factory.

CHOOSE YOUR ELEMENTS

- Refer to element specifications to appropriately select elements.
- Total the wattage of the system.

CHOOSE YOUR CONNECTED POWER UNIT (CPU)

- Select remote mount or surface mount (using side knock out provisions) CPU.
- Select appropriate wattage based on total system wattage.

Note: recommended sizing up as feasible for increased system capability.

ACCESSORIZE

- Add channel covers, lenses, or glare control accessories as desired.

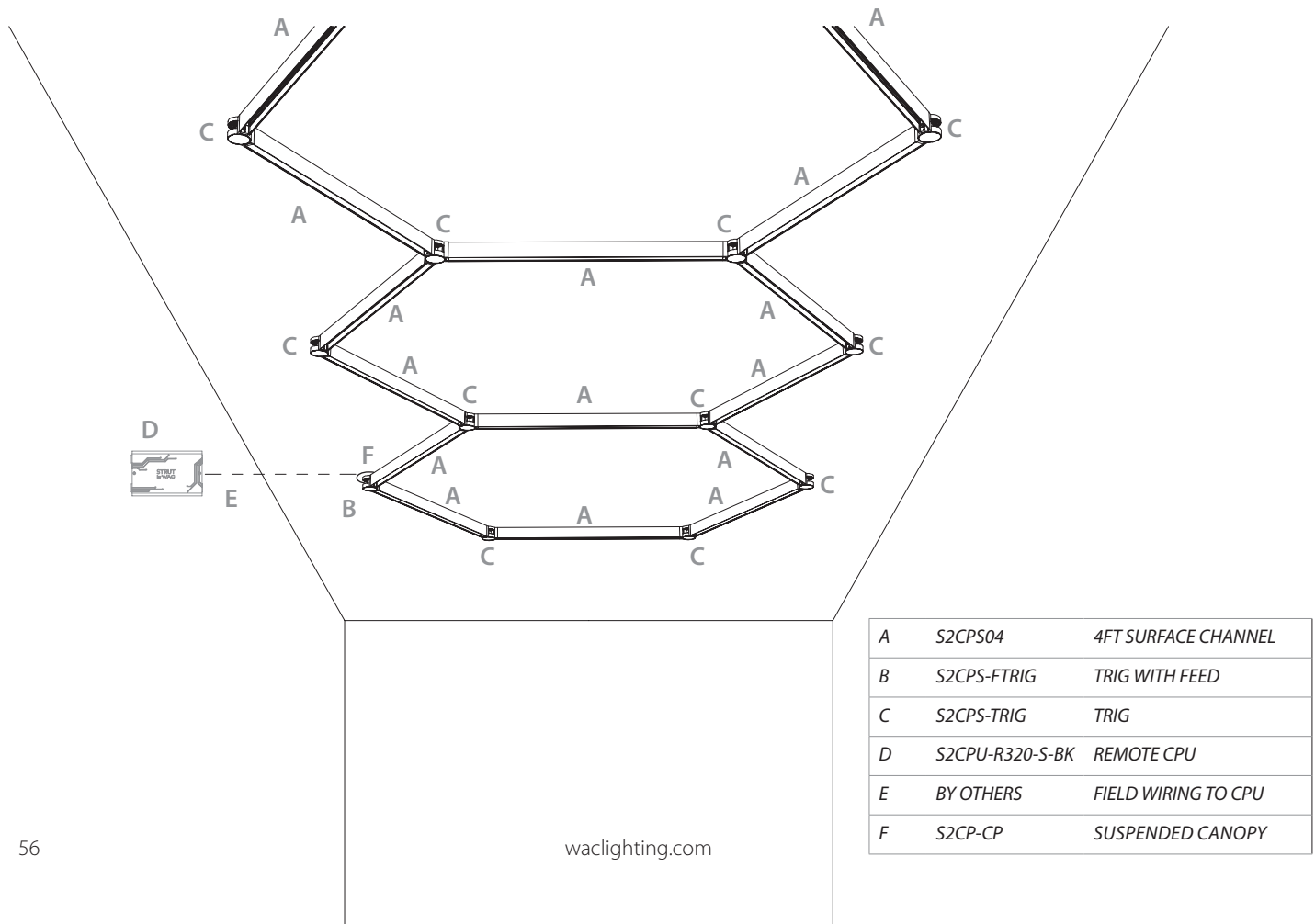

SURFACE CHANNELS

System	Model	Length	Finish
S2	CPS01	1 ft Surface Channel	Connected Power Unit Required See page 44 (sold separately)
	CPS01.5	1.5 ft Surface Channel	
	CPS04	4 ft Surface Channel	
	CPS08	8 ft Surface Channel	
	CPS12	12 ft Surface Channel	
			BK Black WT White

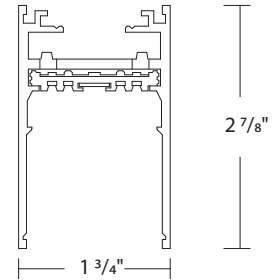

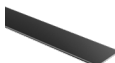

Example: **S2CPS04-BK** Each section comes with two matching end caps and may be cut at end run.

CHANNEL COVER







	Channel Cover 8ft 8ft length may be field cut, Suitable for top or bottom channel coverage.	S2C-COV08	BK Black WT White
---	---	------------------	------------------------------------

TRIG



	Model	Finish
 Trig with Feed Includes 96in feed wire, and 2 channel connectors. Canopy sold separately.	S2CPS-FTRIG	BK Black WT White
 Trig Includes 2 channel connectors.	S2CPS-TRIG	BK Black WT White
 Adapter Additional Trig connectors	S2CPS-NADP	BK Black WT White

See page 46 for more information about the TRIG hub connector system



CONNECTORS

	Model	Finish
 Feed End Includes 24in feed wire	S2CS-FE	BK Black WT White
 Feed End Junction Box 3in junction box with side knockouts	S2CS-FEB	BK Black WT White
 I Connector Joins two channel sections with electrical continuity	S2CSR-I	BK Black WT White
 Dead I Connector Joins two channel sections without electrical continuity	S2C-ID	BK Black WT White
 L Connector Joins two channel sections 90°. Feed separately	S2CPS-L	BK Black WT White
 T Connector Joins three channel sections. Feed separately	S2CPS-T	BK Black WT White
 X Connector Joins four channel sections. Feed separately	S2CPS-X	BK Black WT White
 Inside Corner Joins ceiling to wall channel sections	S2CS-IC	BK Black WT White
 Outside Corner Joins wall to wall channel sections	S2CS-OC	BK Black WT White
 End Cap Additional end cap	S2CPS-EC	BK Black WT White

CONNECTORS

	Model	Finish
 Surface/Suspended to Recessed Corner Joins suspended or surface mounted channel to recessed trim channel	S2CPST-IC	BK BK Black/Black BK WT Black/White WT WT White/White WT BK White/Black
 Surface/Suspended to Recessed Corner Joins suspended or surface mounted channel to recessed trimless channel	S2CPSL-IC	BK BK Black/Black WT BK White/Black

SUSPENSION HARDWARE

	Model	Finish
 Canopy Covers a standard 4in junction box. Use with Trig with Feed	S2CP-CP	BK Black WT White
 Suspension Loop Mechanical loop Supports up to 15 lb	S2C-LOOP	BK Black

STRUT

DIRECT ELEMENTS	18
INDIRECT ELEMENTS	20
STEALTH WALL WASH	22
MULTI STEALTH DOWNLIGHT	24
STEALTH DOWNLIGHT	26
STEALTH SILO	28
SILO	30
FOLLOW SILO	32
SILO PENDANT	34
NIVEOUS PENDANT	36
ELEMENTUM PENDANT	38
FLARE PENDANT	40
VOLO PENDANT	42

COMPONENTS AND ACCESSORIES

REMOTE CPU	44
SURFACE MOUNTED CPU	45
VACANCY PHOTO SENSOR	46
TRIG HUB SYSTEM	48
RECESSED CHANNELS WITH TRIM	50
TRIMLESS RECESSED CHANNELS	52
SUSPENDED CHANNEL	54
SURFACE MOUNTED CHANNEL	56

Headquarters

Tel: 800.526.2588

Fax: 800.526.2585

West Coast Factory

1750 S Archibald Ave
Ontario, CA 91761

East Coast Factory

44 Harbor Park Dr
Port Washington, NY 11050

Central Factory

1600 Distribution Ct
Lithia Springs, GA 30122

Consult the factory to take advantage of our
custom capabilities in large quantities. For up to date
product specifications and assistance please
visit waclighting.com
or call
1-800-526-2588



TITLE 24
CALIFORNIA

This catalog includes many patent-pending products or features. We will not hesitate to enforce our intellectual property rights through injunctive relief and seek further relief through damages if we have reason to believe the patents are being infringed.

Copyright © 2021 by WAC Lighting. All rights reserved. This catalog is copyrighted and WAC Lighting reserves the right to use any and all measures available to it under the law against anyone who copies or derives from its copyrighted work.